

Elucidating the Mechanism Governing the Cell Rotation Behavior under DEP

Yu Zhao¹, Johnnie Hodge¹, Jozef Brcka³, Jacques Faguet³, Eric Lee³, Guigen Zhang^{1,2,4*}

¹Department of Bioengineering, Clemson University, Clemson, SC 29634

²Department of Electrical and Computer Engineering, Clemson, SC 29634

³Tokyo Electron U.S. Holdings, Inc., U.S. Technology Development Center, Austin, TX 78741

⁴Institute for Biological Interfaces of Engineering, Clemson University, Clemson, SC 29634

* guigen@clemson.edu

Abstract: Rotating electric field has been used to cause cell rotation by generating a constantly rotating dielectrophoretic (DEP) force.¹ Few literature work describes cell rotation under normal DEP condition, leaving the underlying mechanism less understood.² In our experiment of manipulating rat adipose stem cells with parallel interdigitated electrodes under alternating current (AC) DEP, we observed that besides the common alignment behavior some cells constantly rotate in the gap regions and this behavior can be repeated with forward and backward frequency sweep. Using the current theory of DEP it is difficult to find a reasonable explanation. In this study we developed COMSOL models to elucidate the mechanism by applying our new DEP analysis method. The simulation results provide good explanation for the cause of cell rotation.

Keywords: DEP, cell rotation, off-center nucleus, non-uniform shape

1. Introduction

The setup of our experiment is illustrated in Figure 1. At the bottom lies a glass slide containing parallel gold electrodes. A polyethylene insulation layer is used as the cover or insulation layer on top of the electrodes. Cells in a glucose/sucrose mixture solution are dispensed onto the cover layer. A glass cover slip is used to ensure a uniform height of the liquid layer which helps eliminate the flow of cells caused by forces other than the DEP forces. A functional generator and an amplifier are used to provide sine wave AC potential.

In parallel, a 3D electrostatic COMSOL model is developed to simulate the DEP forces exerted on the cells suspended in the medium as shown in Figure 2. The three colored rectangles are electrodes with width of 50 μm . The gap distance between electrodes is 100 μm . The thickness of the insulation layer is 3 μm . The three electrodes are biased at 20V and ground in an alternating order. A particle is introduced to represent a cell and the presence of the

particle is considered to alter the distribution of the surrounding electric field.

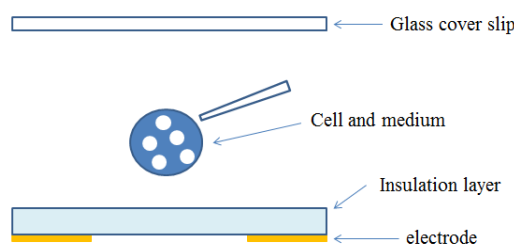

Figure 1. Setup of experimental design

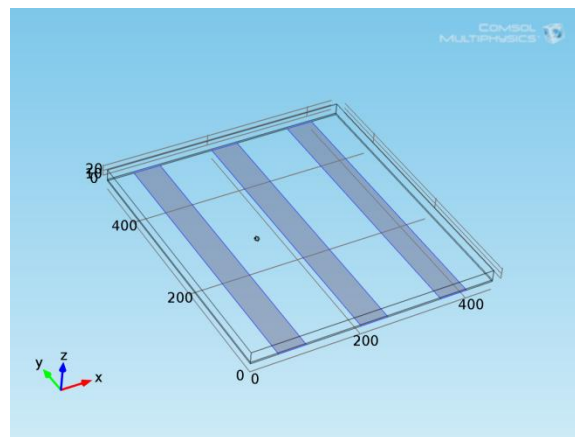

Figure 2. The 3D model based on experiment design

2. Governing Equations

The conventional equation for DEP has been derived for sphere-shaped particle and used ubiquitously. While in general it works fine in explaining some experimental phenomena, especially the general movement direction of particles under different frequency, it fails to elucidate many important observations in our experiments, including the cell rotation behavior. Here we develop a new integration method to elucidate various interesting phenomena of DEP.

2.1 Conventional DEP force equation

For spherical particle, the DEP force can be expressed as³

$$F = 2\pi a^3 \varepsilon_0 \varepsilon_m \operatorname{Re} \left(\frac{\varepsilon_p - \varepsilon_m}{\varepsilon_p + 2\varepsilon_m} \right) \nabla E_{rms}^2 \quad (1)$$

where a is the radius of the particle, ε_p and ε_m are the complex permittivity of particle and medium respectively ($\varepsilon = \varepsilon' - j \frac{\sigma}{\omega}$), E is the electric field strength.

This expression shows that the magnitude of the force is proportional to the volume of the particle and the gradient of electromagnetic energy. The direction of the force under a fixed electric field is determined by the Clausius-Mossetti (CM) factor $\frac{\varepsilon_p - \varepsilon_m}{\varepsilon_p + 2\varepsilon_m}$. Since both the permittivity of the particle and the medium depend on frequency, the force may experience certain transition process as frequency changes. Thus this equation is limited in the following areas

- I. The inconsistency in the use of permittivity
- II. The size effect not correctly reflected
- III. The dipole-dipole interaction not included

In Equation (1), permittivity is considered as a complex number in the CM factor but is regarded as a real number in medium permittivity and electric field calculations. This may not be a problem if only a rough estimation of force is needed, especially when the size of particle is very small compared with the width of electrodes.

In deriving the above equation, an assumption was made that the electric field is uniformly distributed inside the particle. In reality, the electric field density changes depending on the size of particle. When two particles get close to each other, their dipoles will interact with each other leading to redistribution of electric field. This interaction governs the alignment pattern of particles, which will have many significant implications in practical applications.

2.2 New DEP force expression

To eliminate the inconsistency of permittivity we use a real expression of conductivity

($\sigma = \sqrt{(\sigma')^2 + \omega^2 \varepsilon^2}$) to represent the dielectric properties of particle and medium since conductivity and permittivity are interchangeable. Based on the dipole force given in expression (2) and dipole-polarization relation given in (3),

$$F = (m \cdot \nabla) E \quad (2)$$

$$P = \frac{m}{V} \quad (3)$$

the total force can be calculated by integrating the force density over the particle domain as

$$F = \frac{\sigma_p - \sigma_m}{\sigma_p + 2\sigma_m} \varepsilon_0 \int (P \cdot \nabla) E dV \quad (4)$$

By using COMSOL, quantitative values of DEP forces can be determined with this formula. It is worth pointing out that this new DEP force formula does not assume uniform electric field inside the particle. Moreover, it accounts for the dipole-dipole interaction. It can be applied to particles of any geometrical shapes, and it can be used to calculate the DEP force even when the size of particle is comparable to the width of the electrodes.

3. Experimental Methods and Observation

Rat adipose stem cells are washed with glucose and sucrose solution for five times. A drop of solution mixed with cells is dispensed on top of the electrode and the amplified signal from the function generator is applied to the electrodes. By sweeping the frequency from low to high, we note that cells accumulate along the edge of electrodes at first and then move to the center of gap region between electrodes at certain frequency. For those cells in the gap region, some of them start to spin either clockwise or counterclockwise as shown in figure 3. For cells that aggregate to form a conglomerate, it also spins.

Figure 3 shows two images captured at two different times. Although these are still images, one can still see the different orientations of the two cells circled in red and green. The red-circled cell is rotation counterclockwise and the green-circled cell clockwise.

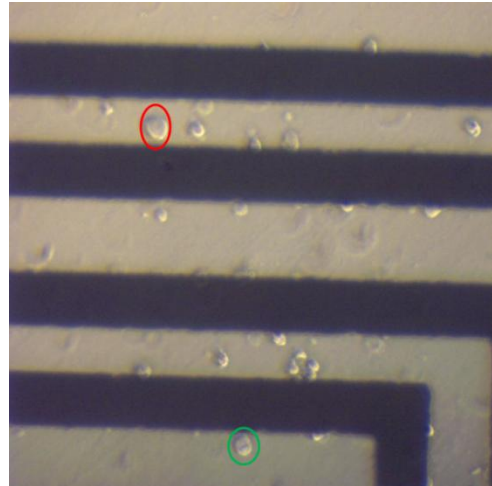

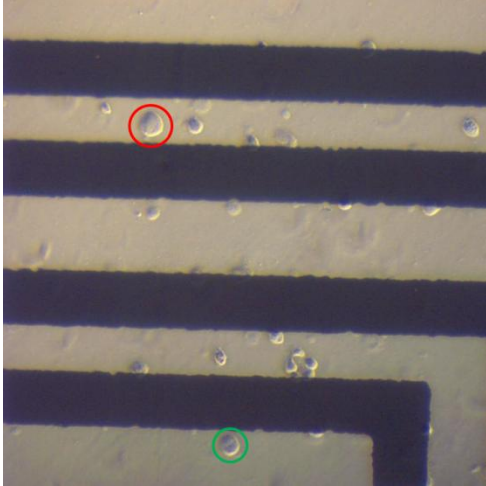

Figure 3. Optical images showing cell rotation under DEP force at 200Vpp and 300KHz

4. Numerical Model

We hypothesized that the cell rotation is caused by the non-circular shape of the cell body and the off-centered location of its nucleus and that the rotation direction depends on the relative location of nucleus with respect to the electrical field.

To validate this hypothesis, we considered ellipsoid-shaped cells with off-centered nucleus. Considering the fact that the nucleus usually stays at a certain location inside the cell due to fixation by cell skeleton, in the model we place the nucleus at two different positions inside the cell which sits at the center gap. The cell nucleus is assigned a higher conductivity value compared than cell plasma due to greater hydrated free ion content,⁴ making the relative permittivity ($\epsilon = \frac{\sigma}{\omega}$) of cell nucleus higher than that of the cytoplasm. For the cytoplasm a permittivity value lower than that of medium is assigned.

We considered two cases as shown in Figure 4. In the first one the nucleus is located above the center line (Figure 4(a)) and in the second one nucleus is located below the center line (Figure 4(b)). In both cases the nucleus is on the right side.

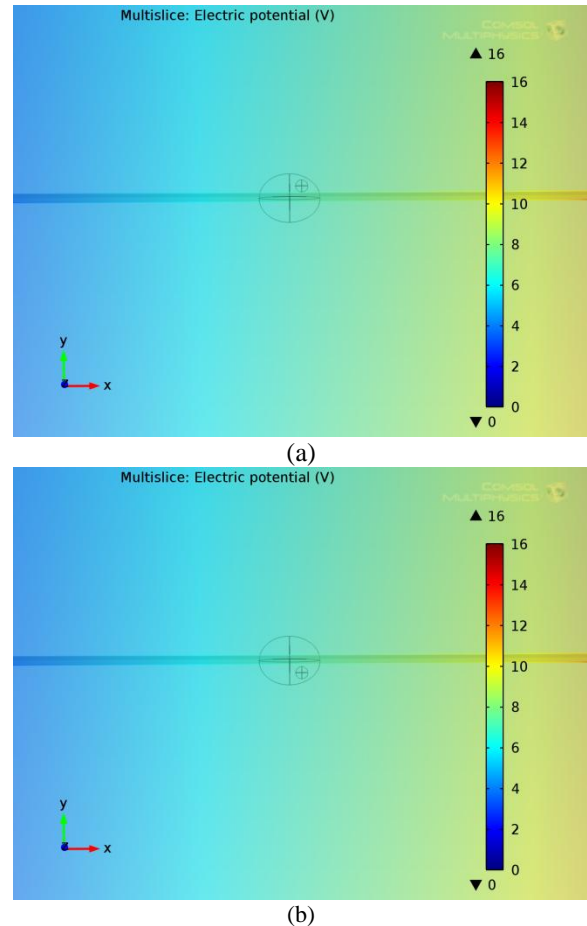
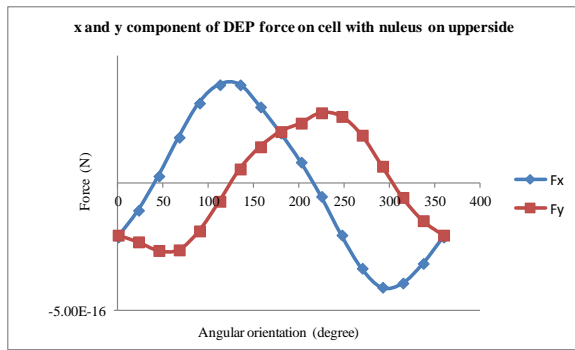

Figure 4. COMSOL model of an ellipsoid shaped cell with an off-centered nucleus

5. Simulation Results

Figure 5 shows the obtained total DEP force as a function of the orientation angle for both cases. We can see in both cases as the cell spins from 0° to 360° , the x-component and y-component of DEP force follow a sinusoidal wave pattern having a 90° phase delay. This means that there exists a nonzero net force causing the cell to rotate in the x-y plane. The rotation direction is determined by the orientations of the net force and the cell.



(a)

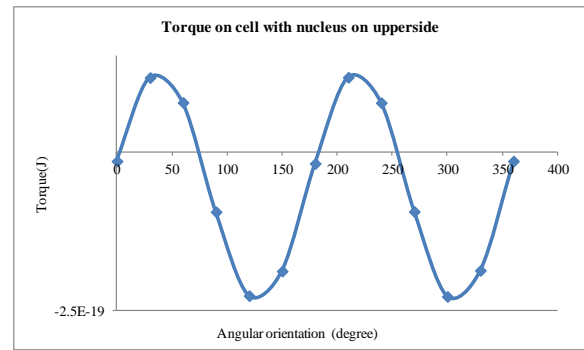

(a)

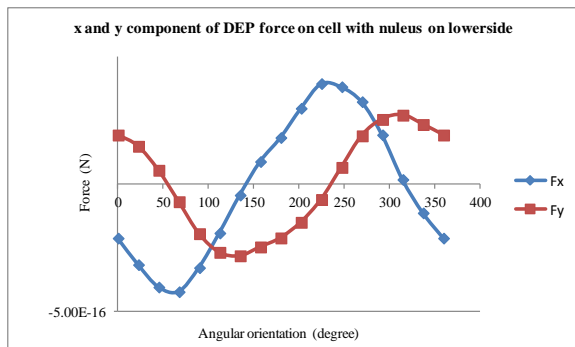

(b)

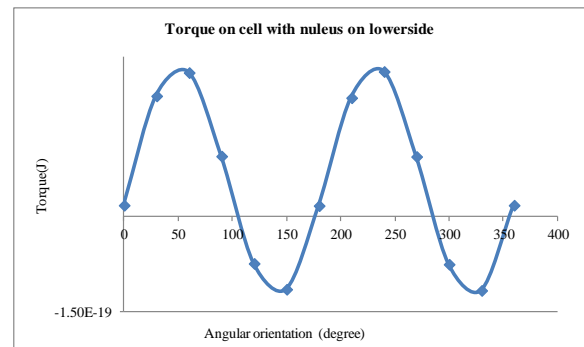

(b)

Figure 5. x- and y-components of net DEP force obtained from an ellipsoid-shaped cell with upper side off-centered nucleus (a) and lower side off-centered nucleus (b)

Figure 6. Torque obtained from an ellipsoid-shaped cell with upper side off-centered nucleus (a) and lower side off-centered nucleus (b)

To decide the rotation direction we calculated the torque exerted on cell for both cases. As shown in Figure 6(a) the cell with its structure given in figure 4(a) is expected to spin clockwise because it is subject to a predominately negative torque most of the time, and Figure 6(b) indicates that the cell with its structure given in figure 4(b) will spin counterclockwise because it is subject to a positive torque most of the time.

We also observed in our experiment that as frequency increases, cells underwent a transition point and started to rotate in the opposite direction. This is caused by the reverse of DEP force direction. Based on our simulation result, we conclude that the more off-centered the nucleus is positioned, the stronger the rotation force. That explains why aggregates of cells are more likely to rotate. Experiment validation is underway to confirm our new theory and new predictions.

6. Discussion

Our new integration method to determine the DEP forces proves to be valid and powerful in explaining the spinning or rotation behavior of cells: in essence the cell spinning is caused by anisotropy in cell body structure. If the cell is just non-spherical, for example, ellipsoid structure, it will rotate to an orientation which has most favorable field energy. The introduction of off-centered nucleus actually causes asymmetry in the direction parallel to electrode.

7. Conclusion

The observed cell spinning or rotation behavior was investigated by using COMSOL modeling. Our hypotheses that the cell rotation is caused by the non-circular shape of the cell body and the off-centered location of its nucleus and that the rotation direction depends on the relative location of nucleus with

respect to the electrical field are confirmed by the simulation results.

Reference:

1. Huang, Y., Hölzel, R., Pethig, R., & Wang, X. B. Differences in the AC electrodynamics of viable and non-viable yeast cells determined through combined dielectrophoresis and electrorotation studies. *Physics in medicine and biology*, 37(7), 1499–517. (1992)
2. Chau, L.-H., Liang, W., Cheung, F. W. K., Liu, W. K., Li, W. J., Chen, S.-C., & Lee, G.-B. Self-rotation of cells in an irrotational AC E-field in an opto-electrokinetics chip. *PloS one*, 8(1), e51577. (2013)
3. Wang, X-B., Huang, Y., Becker, F. F., & Gascoyne, P. R. C. A unified theory of dielectrophoresis and travelling wave dielectrophoresis. *J. Phys. D: Appl. Phys.*, 27,1571. (1994)
4. Pethig, R., Menachery, A., Pells, S., & De Sousa, P. Dielectrophoresis: a review of applications for stem cell research. *Journal of biomedicine & biotechnology*, 2010, 182581. (2010)

Acknowledgement:

This work is a collaborative effort by Clemson and Tokyo Electron U.S. Holdings, Inc., U.S. Technology Development Center. We appreciate the use of Clemson’s Palmetto Cluster computing resources and the supports from Clemson Bioengineering and the Institute for Biological Interfaces of Engineering.

Appendix:

Table 1. Parameters for COMSOL modeling

| | | |
|-----------|------------------------------------|-------|
| width | Width of electrodes | 50um |
| length | Length of electrodes | 500um |
| gap | Gap distance between electrodes | 100um |
| a | Long axis of cell | 5um |
| b | Short axis of cell | 3um |
| d | Thickness of insulation layer | 3um |
| per_c | Relative permittivity of cytoplasm | 60 |
| per_n | Relative permittivity of nucleus | 100 |
| per_m | Relative permittivity of medium | 80 |
| potential | Potential applied on the electrode | 16V |