

COMSOL NEWS

THE MULTIPHYSICS SIMULATION MAGAZINE

Competing in Hyperspeed

Students travel from Switzerland to California with multiphysics

PAGE 14

Competing in Hyperspeed

Whether it's a competition entered by a group of students or the pressure of staying competitive in today's cutthroat marketplace, multiphysics simulation speeds up the workflow for engineers everywhere.

Very few ideas or products come to fruition through the work of one single person. Collaboration is key when designing products that will change our future in unforeseeable ways. In this year's issue of COMSOL News we find that everyone from students to professionals are working together. Both with each other and their customers to uncover the next development in their design work. Ingraining a strong sense of teamwork in young engineers will enable them to outperform their peers once they arrive in the workforce. Beyond academia it is imperative to have both the technical skills to do your job, and as well as the communication skills to work well with others.

This issue informs readers about the teamwork involved in a variety of multiphysics projects from electromagnetic flowmeters at ABB, and radiant heating and cooling at Viega, to simulation applications that help us pave the road towards democratization. Our cover story features students at EPFL who teamed up on this multidisciplinary project to study the fluid, electrical, mechanical, and materials science phenomena required to design and build their hyperloop pod.

We are excited to present to you all of the COMSOL users who shared their expertise and insights throughout the following pages.

Enjoy!



Natalia Switala
COMSOL, Inc.

INTERACT WITH THE COMSOL COMMUNITY

BLOG comsol.com/blogs

FORUM comsol.com/forum

LinkedIn™ linkedin.com/company/comsol-inc

Facebook® facebook.com/multiphysics

Twitter® twitter.com/@COMSOL_Inc

We welcome your comments on COMSOL News; contact us at info@comsol.com.

COMSOL NEWS

© 2019 COMSOL. COMSOL, COMSOL Multiphysics, Capture the Concept, COMSOL Desktop, COMSOL Server, and LiveLink are either registered trademarks or trademarks of COMSOL AB. All other trademarks are the property of their respective owners, and COMSOL AB and its subsidiaries and products are not affiliated with, endorsed by, sponsored by, or supported by those trademark owners. For a list of such trademark owners, see www.comsol.com/trademarks.

LinkedIn is a trademark of LinkedIn Corporation and its affiliates in the United States and/or other countries. Facebook is a registered trademark of Facebook, Inc. TWITTER, TWEET, RETWEET and the Twitter logo are trademarks of Twitter, Inc. or its affiliates. Google+ is a trademark of Google LLC.

CONTENTS

RADIANT HEATING & COOLING

- 4 | The Unseen Wonders of Radiant Heating, Cooling, and Snowmelting



SIMULATION APPLICATIONS

- 7 | Democratizing Simulation with Simulation Applications

DIGITAL TWINS

- 10 | ABB's Electromagnetic Flowmeter Digital Twin Drives Performance

HYPERLOOP POD DESIGN

- 14 | Inspiring Young Engineers to Design for the Future at EPFL

OPTICAL ANTENNA DESIGN

- 16 | Virtually Optimizing Metasurface Topology with a Genetic Algorithm

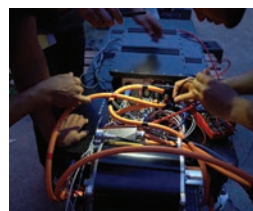

ON THE COVER

Students from EPFL routing their hyperloop pod's power cabling. Image courtesy: EPFL

FEATURES

THERMAL MANAGEMENT OF BUILDINGS

19 | Complex Fenestration System for Energy Efficiency

SIMULATION APPLICATIONS FOR TEACHING

22 | Adding Quantitative Systems Pharmacology to the Pharmaceutical Sciences Curriculum

SEISMIC ENGINEERING ANALYSIS

24 | Seismic Safety Evaluations of Dams with Numerical Simulation

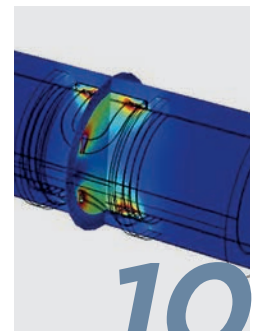
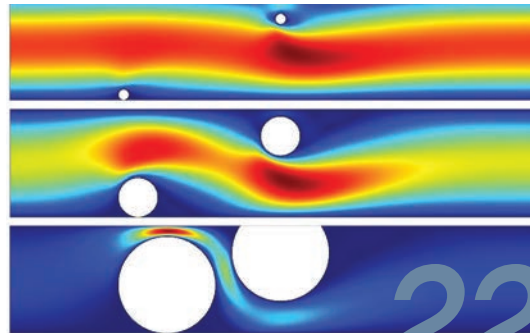
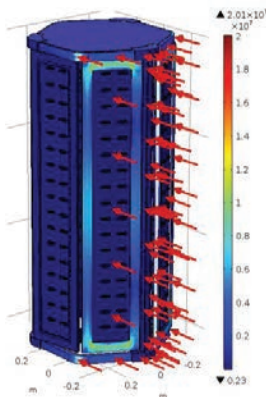

SMART CITIES

27 | Multiphysics Simulation Drives Smart City Technology

BATTERY DESIGN

30 | Keeping Dendrites at Bay with Numerical Simulation

GUEST EDITORIAL

32 | Collaboration is Key for Individualized Medicine

rot_rpm: 0

rot_rad: rot_rpm/60*2*pi

gravity: 1

ant_curv: 9.93 mm

pos_curv: 6.69 mm

thic: 9.07 mm

pressage: 0.00 mm

nucleus_f: 1

grav: rm1(t(1/s))

spring: rm2(t(1/s))

Calculer

nucleus_f(1)=0.5 Temps=2.5 s Surface: Déplacement total (mm) Flèches sur surface: Champ de déplacement Isovaleurs: Contraintes de Von Mises (N/m²)

Graphique ponctuel: Déplacement total (mm)

32

THE UNSEEN WONDERS OF RADIANT HEATING, COOLING, AND SNOWMELTING

Engineers at Viega use simulation applications to share results of finite element modeling with their customers, offering them valuable engineering support as they design radiant heating and cooling systems for both residential and commercial applications.

by **NICOLAS HUC**

Imagine the race against time that emergency workers compete in on a daily basis, as well as, the panic, stress, adrenaline, and rush that comes with driving an ambulance or emergency helicopter. Now, imagine the emergency worker arriving on scene in the dead of winter, only to find the helicopter landing zone covered in ice and snow. Under such intense time constraints, can this area be shoveled quickly enough? What about emergency vehicles slipping on hidden ice? Is it worth the risk to be held at the mercy of these arctic conditions with such high stakes?

Fortunately, there is technology that can safeguard against these issues, and it is becoming increasingly prominent: hydronic snowmelt systems. Piping encased in a thermal mass (typically concrete) allows for warm water to circulate throughout the area requiring snowmelt. With regards to an emergency situation, when designed properly, the system will prevent the buildup of ice and snow, thus alleviating the need for manual cleanup.

When it comes to applications where heating or cooling is required, radiant floor systems use a similar piping design to control space temperature and comfort by regulating the flow and temperature of water in tubing installed beneath the floor (Figure 2).

Viega, a company that both designs and manufactures radiant heating systems, helps tackle situations where special methods of temperature control are needed.



FIGURE 1. Emergency helicopter hangar for patient transport.

⇒ RADIANT FLOOR SYSTEMS

Although they have existed in various forms since the Roman Empire, radiant systems are turning out to be particularly useful in modern society for both commercial and residential applications. Radiant heating is used not only for floor warming applications but also to control the temperature of a room. When the floor can be kept at a warm temperature, it will give off thermal radiation in the room. This radiation will only be absorbed by opaque surfaces; in other words, it will be absorbed by our bodies (but not the air), creating a feeling of warmth.

A tubing layout is designed in a specific configuration by Viega. The tubing is then laid beneath the flooring in a panel system. Hot water (or cold water in cooling applications) runs through the tubing and heats the surrounding material. The uppermost surface of the floor then radiates heat

to the rest of the room. This is just like when you move from a shady spot to a sunbathed one; although the air temperature is the same, your skin feels much warmer because of the absorption of thermal radiation. The special tubing is made of a cross-linked, high-density polyethylene (known commonly as PEX). The cross-linking benefits are two-fold: It provides the capability to withstand higher temperatures and pressures and increases its resistance to stress cracking. These tubes are vigorously tested, adhering to standards for temperature and pressure ratings, minimum bending radii, and pipe wall thickness.

The recent emergence of environmental consciousness and energy efficiency at the forefront of building design has contributed strongly to the increased popularity in radiant heating. Radiant heating systems pair quite well with modern, high-efficiency water boilers, and since they don't circulate air

and utilize lower water temperatures than a baseboard system (115°F vs. 180°F), they optimize the energy consumption. The water temperature in the tubing distribution is simply controlled by the opening and closing of valves and even yields a more constant temperature throughout the room.

⇒ SYSTEM DESIGN

Brett Austin, supervisor of heating and cooling design at Viega, uses the COMSOL Multiphysics® software to design a system to meet their customers' needs. "COMSOL® supplements our heating and cooling design and layout program," Austin says. "We draw the layout on floor plans, move it into COMSOL, and eventually share it with customers. Simulation allows us to provide engineering data to support our designs." When a project is proposed to them, a mechanical engineer from the site provides requirements for heating and cooling outputs, structural specifications, floor covering materials, and usually a range of acceptable water temperatures. They then use simulation to determine tube placement and spacing, temperature distributions (Figure 3), and heating or cooling capacity to make sure the customers' needs are met. COMSOL is primarily helpful for nonstandard applications where there is multidirectional output or more complex structures," Austin says.

Viega truly benefits from multiphysics simulation through the use of simulation applications and COMSOL Server™ to share them with their customers. When Viega's team is at meetings with prospective customers, they can now quickly adjust parameters, like water temperature or tubing diameter, and show the output of the heating or cooling system on the spot. "Prospective customers often have many initial questions involving multiple iterations," Austin explains. "But the simulation applications allow us to go above and beyond and offer them the invaluable service of visualization. It is a great tool that allows us to share data virtually anywhere in the world from our office."

⇒ ARTIC

In environments like Southern California, cooling contributes more to comfort

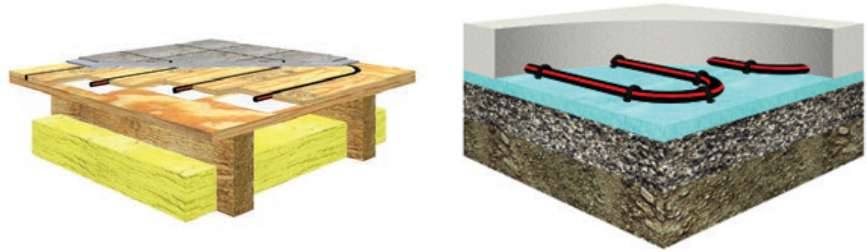

FIGURE 2. Radiant tubing in climate panel (left). Radiant tubing in concrete (right).

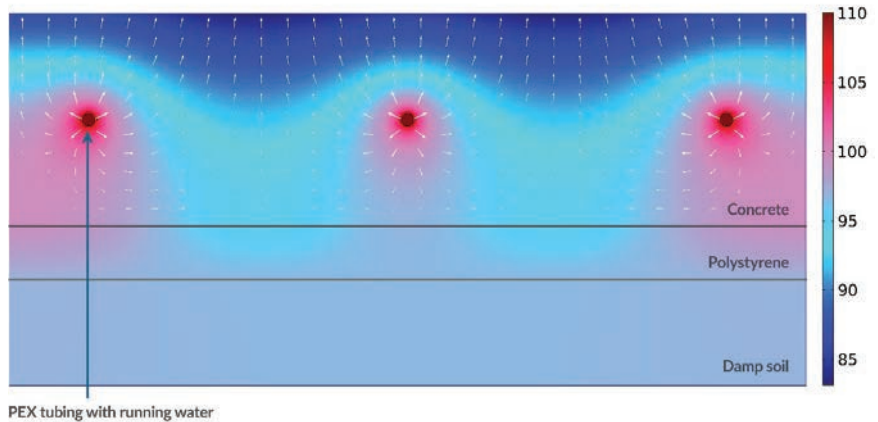

FIGURE 3. Cross-sectional temperature distribution of a radiant heating system. The arrows denote the direction of the conductive heat flux, showing the rate of heat transfer to the upper surface of the floor and thus the air above. Temperatures are shown in °F.

than heating. That's why the Anaheim Regional Transportation Intermodal Center (ARTIC, Figure 4) came to Viega about installing a radiant cooling system. Because of the massive size of the building, a forced-air circulation system would be near impossible to achieve and hopelessly expensive. Once again, the team underwent the task of modeling smaller sections of flooring and extrapolating the data to the entire layout. This scenario, however, had some added difficulty and required quite the balancing act from Austin. For starters, because of the dome-shaped structure and high amount of window space (Figure 5), there were abnormally high solar gains that added significant heat energy to the building. The cooling capacity, therefore, had to be very high to counteract this. On the flip side, because of constraints from the engineers on the ARTIC side, the water temperatures in the tubing had to be much lower than usual cooling systems (50°F vs. 58°F); but as temperatures neared dew point at the surface of the floor in some areas that had closely

spaced tubing, Viega wanted to ensure peace of mind to the customer that condensation was not a concern.

Using COMSOL Multiphysics, they were able to determine what to do to prevent condensation from forming; installing a thin layer of insulation around the pipe. "We worked out a solution with the onsite engineer to add an insulation layer on top of the supply tubing to slightly reduce the output," Austin says. "It seems counterintuitive, but in this case, it prevents condensation in areas that had closely spaced tubing due to construction constraints." Additionally, on other projects, they have used COMSOL to run time-dependent simulations to help develop a control strategy where the slabs in the floor are cooled overnight to conserve energy. The chilled water is run throughout the night, cooling the concrete to a low temperature. In the morning, the water is turned off and the floor temperature stays cool for the remainder of the day. This contributes strongly to the reduction of necessary cooling power. Simulation was used to see how long the output will



FIGURE 4. The Anaheim Regional Transportation Intermodal Center (ARTIC).

continue throughout the day and if this is a feasible strategy.

⇒ **SUN VALLEY SKI RESORT**

Even though snow-melting systems can act as a critical safety feature for emergency entrances and helicopter landing pads, they can be equally as useful at the other end of the spectrum: luxury. High-end ski resorts place extreme value on their customers' safety, and a sophisticated and reliable snow-melt system is essential to their experience. In a snow-melt system, the ground is kept at a warm temperature, which continuously melts snow and ice.

When Sun Valley Ski Resort, located in Ketchum, Idaho, came to Viega, Austin knew how sizeable a task they were about to undertake. The ski resort wanted to install a radiant snow-melting system throughout the entire resort, requiring more than 60,000 square feet of walk areas and driveways. To deal with such a large project using simulation, Austin and his team had to model sections of the system. "Fortunately, there are similar types of panels throughout most jobs," he explains. "We used our internal program to draw out a section in a CAD format. Then we'd draw a small cutpiece in the software, specify the radiant panel material properties and water temperatures, and then run the simulation." Simulation applications made it seamless to present the results to

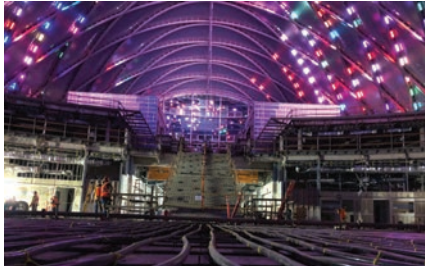

FIGURE 5. Top: ARTIC with radiant heating system installed, prior to the actual flooring being laid. Bottom: End result of the inside of ARTIC.

Sun Valley representatives and played a major part in completing this job.

Sun Valley Ski Resort benefitted tremendously from Viega's design and installation. All pathways and areas with high foot traffic were involved (Figure 6). As it was not always feasible to plow or shovel these areas, another method of snow removal was needed. A snow-melt system such as this minimizes any cleanup, reduces maintenance, and contributes to a professional appearance as there is no need for salt or chemicals.



The team at Viega. From left to right: Liam Collins, Associate Radiant Design Engineer; Travis Simoneau, Associate Radiant Design Engineer; Josef Marcum, Radiant Design Engineer; and Brett Austin, Supervisor, Heating and Cooling Design.



FIGURE 6. The tubing installed at Sun Valley Ski Resort in Idaho.

It also, most importantly, adds an extra level of safety and reduces liability by allowing for "ice-free" zones.

⇒ **CONTINUING WITH COMSOL SERVER™**

COMSOL Server has provided a robust solution to couple Viega's services with their sales team. "COMSOL has given much added value to our work and extended finite element modeling to our sales team," Austin says. "It was very intuitive and easy to pick up the software and we plan on using more coupled physics interfaces in the future to increase our modeling capabilities." ❖

DEMOCRATIZING SIMULATION WITH APPLICATIONS

Simulation applications (and the ability to distribute them) benefit organizations by making modeling accessible to a wider range of engineers, colleagues, and customers.

by **THOMAS FORRISTER**

Simulation is a powerful tool that enables users to save time and money by studying physics phenomena within designs to predict operating conditions before prototyping. However, computational modeling is often left to the simulation specialist, which can limit resources and production within a company. While other team members may not be experts in simulation, their insights can be invaluable to research, design, and manufacturing processes.

Extending the reach of multiphysics simulation enables companies to get higher-quality products to market faster and cheaper than by developing iteration after iteration of a prototype. By creating and distributing simulation applications, specialists can include nonexperts in simulation in the process, demystifying it and breaking down barriers within an organization so that there is more room for collaboration, prediction of outcomes, innovation, and optimization.

At Veryst Engineering, AltaSim Technologies, and GLL Bio-Med Analytics, building and distributing applications helps make their customers' design workflows more efficient.

⇒ APPLICATION DEVELOPMENT AND DISTRIBUTION MADE EASY

Applications enable anyone to test parameters and run repeated analyses without a simulation specialist. This larger group of customers or colleagues without engineering backgrounds can make quick, informed decisions with

confidence. This way, teams can work together more effectively.

To get an overview of the workflow from model to application, a simulation expert will start by creating a model in COMSOL Multiphysics®. Then, the expert can use the Application Builder in COMSOL Multiphysics to turn the model into an application. Applications can be created in minutes using drag-and-drop functionality. The result is a specialized interface with restricted inputs and outputs, so that the end user focuses only on the parameters pertinent to their work.

"The application development process itself is very easy and user friendly," says



FIGURE 1. Users can access applications via COMSOL Server™ and run them on a web browser or client.

Nagi Elabbasi from Veryst Engineering, a consulting firm that offers simulation expertise to customers. He added that applications have a lot of functionality, and for Veryst, they are also a good marketing tool. As Elabbasi explained, "In the applications, you have access to extensive Java® functionality," which means that Veryst can link applications to their material library, PolyUMod, allowing for even more advanced application development to share with their customers.

To give collaborators access to

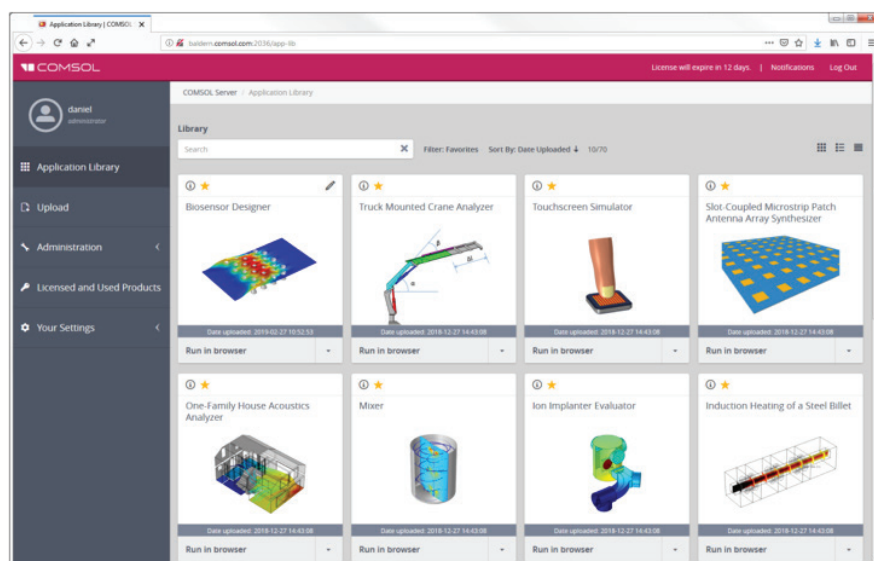

FIGURE 2. Applications and their usage can be managed using COMSOL Server™.

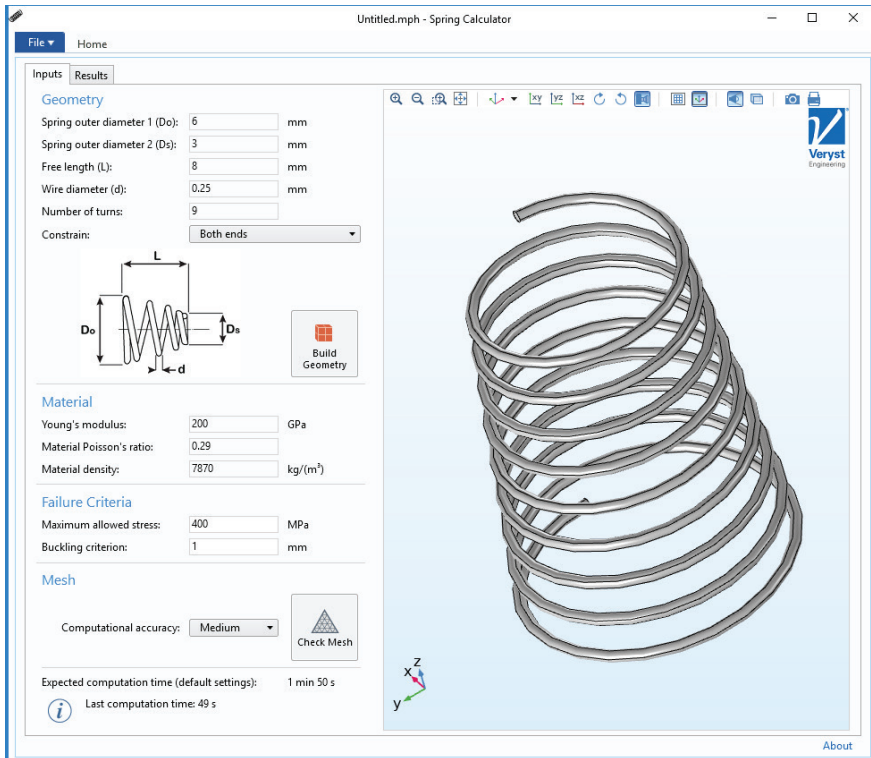

FIGURE 3. A spring calculator application. Image courtesy Veryst Engineering.

applications, there are two methods: compiling standalone executable files or distributing them via an application-management tool. As the name implies, COMSOL Compiler™ is used for creating compiled applications that can be run without a COMSOL® software license on Windows®, Linux®, or macOS. COMSOL Server™ is the choice for those who want to upload and manage applications for their organization and let their application users run simulations via web

browser or client (Figures 1–2).

⇒ PRESENTING SIMULATION APPLICATIONS AS CUSTOMER SOLUTIONS

The ways in which consultants use simulation applications with their customers varies. For instance, GLL has received positive feedback from their customers about how applications allow even those without a physics background to run analyses. "You can see a light

going on in their head," says Gary Long of GLL, "when they realize they can produce their own simulations and results."

Sometimes, a customer realizes the possibilities opened up by applications after working with a model developed for them. In Veryst's experience, customers will "realize how the model is useful to them, want to use it internally, and then they see how an application can help them do that," says Elabbasi, adding that the more the awareness of applications spreads, the earlier they will be able to introduce applications when working with customers.

At AltaSim, applications come into play after learning more about what their customers need. "We go through a lot of discovery with our clients to understand what it is, exactly, that they're looking for," says Kyle Koppenhoefer of AltaSim, "and if we find some key parameters, then we typically suggest an application."

⇒ BUILDING SPECIALIZED APPLICATIONS TO MEET A VARIETY OF CUSTOMER NEEDS

Even the most complex models can translate into easy-to-use interfaces (applications). Veryst's customers use applications to simulate design variations and perform parametric studies and sensitivity analyses, which "helps them focus on their core expertise of improving the product," says Elabbasi, "and not worry about the simulation settings." Some of Veryst's customers just use applications as interactive model viewers

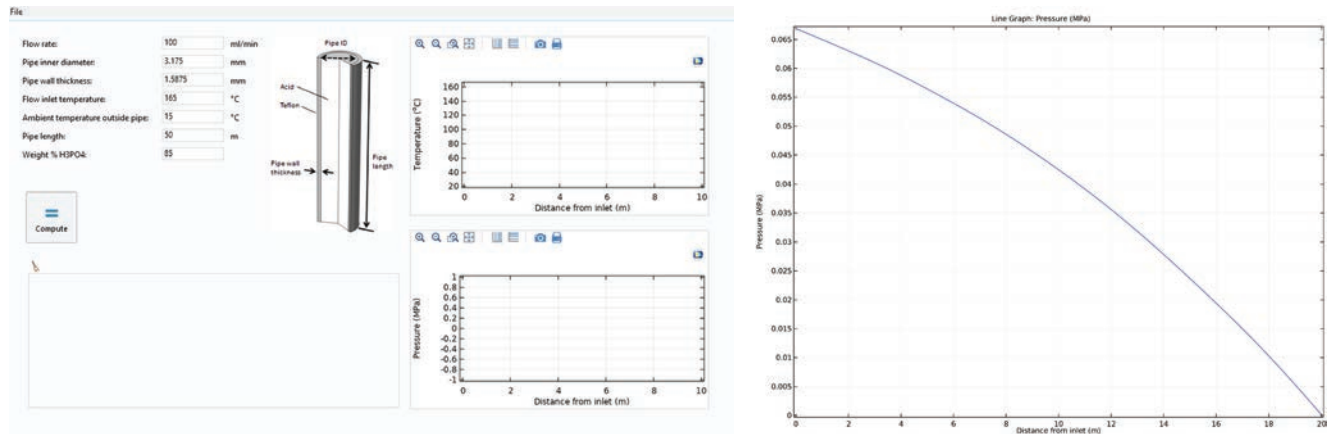

FIGURE 4. An application can be built with restricted inputs (left) and outputs (right) for ease of use. Image courtesy AltaSim Technologies.

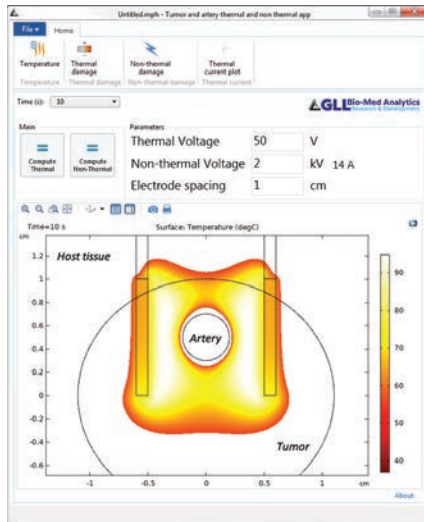

FIGURE 5. Two simulations in one application: a thermal and nonthermal tumor ablation application created by Gary Long of GLL. Image courtesy GLL.

that enable them to visualize model results in 3D, including rotating the model, looking at results at different cross-sections or at different times, and more (Figure 3). That helps them better understand the model predictions.

Applications enable organizations' internal simulation experts to focus on more advanced modeling projects by distributing applications to other teams.

Koppenhoefer says that applications give field engineers a better understanding of how their designs operate, so they are better able to make design decisions.

AltaSim assists with their customers' challenge of reducing rework. For example, variations in factors like temperature and flow rate make it difficult to accurately predict a device's real-world behavior, leading to designs that have to be continuously reworked. This process can be greatly reduced with applications, because

“Customers will realize how the model is useful to them, want to use it internally, and then they see how an application can help them do that.”

— NAGI ELABBASI, VERYST ENGINEERING

engineers from a range of specialties can run as many tests as they need, leading to increased productivity and revenue. (Figure 4)

Many of GLL's customers are medical device startups that often perform their own experiments. GLL simulates these experiments to demonstrate the accuracy of modeling to their customers. "It's very powerful to see the [simulation] results and compare them to experimental results," says Long. They then build applications from the validated models to get simulation engineers, application users, and other team members (often doctors) on the same page by visualizing simulation results in real time.

GLL built a medical device application (Figure 5) that simulates thermal and nonthermal tumor ablation. The

application helps engineers design devices that ablate cancer cells, visualize ablation zones, and even import MRI and CT scans for specific anatomies. The user interface for the application includes a menu so that users can easily choose a study. For instance, because the temperature and thermal necrotic zones are time dependent, users can specify a time at which they can see the damage due to the heat or temperature profile in the results (Figure 6). The application includes three inputs for parameters: thermal voltage, nonthermal voltage, and electrode spacing. The current can be plotted via the experimental current so that users can easily validate the simulation.

⇒ COLLABORATION PROMOTES INNOVATION

As illustrated by these three simulation experts, the democratization of applications is well underway. The Application Builder makes it simple to build a simulation application in as little as a few minutes, and COMSOL Server and COMSOL Compiler help bring the applications to the people. Through the democratization of simulation, specialists, researchers, engineers, and customers can develop and innovate by working together. ❖

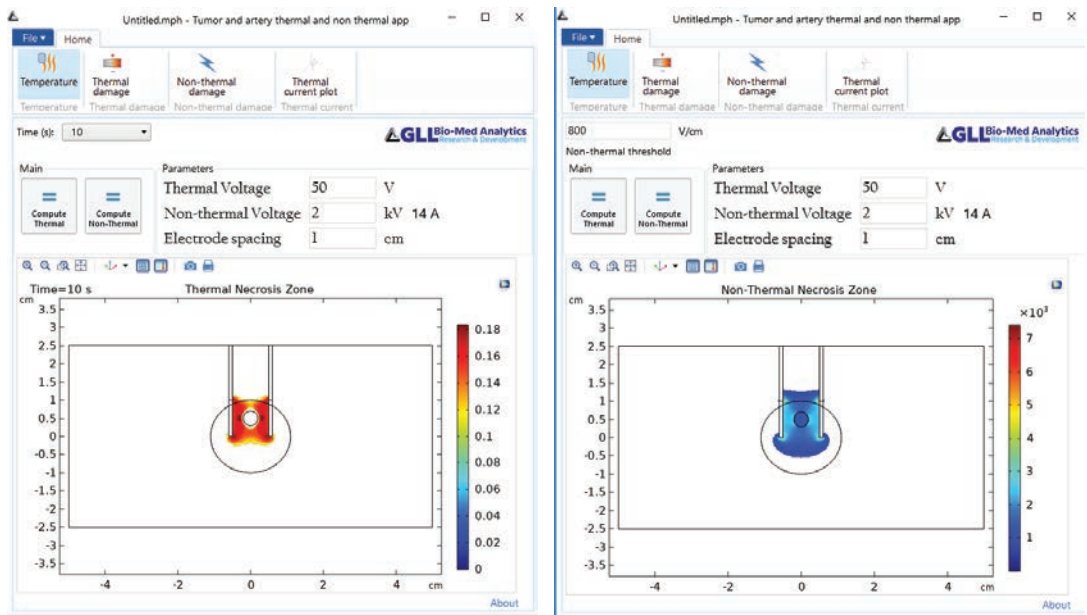

FIGURE 6. A medical device application enables users to study thermal or nonthermal necrosis zones. Image courtesy GLL.

ABB'S ELECTROMAGNETIC FLOWMETER DIGITAL TWIN DRIVES PERFORMANCE

ABB's flow measurement products reflect state-of-the-art developments in flow sensing technology. ABB's new tool, a digital twin, mimics the actual flowmeter in a virtual environment and predicts electromagnetic (EM) flowmeter performance. The digital twin based on multiphysics modeling enables flowmeter design improvement and performance prediction under field conditions.

by **SUBHASHISH DASGUPTA** and **VINAY KARIWALA**

During the last decade new technologies and digitization have begun to dramatically impact conventional process industries involving liquids, such as water and wastewater transport and treatment. As these exciting applications have become more plausible and available, ABB's dedicated research teams have worked to ensure customers receive the best and most cost-effective tools to improve their competitive edge. Digital twin technology can do just that by enabling the detection of physical issues early on and predicting outcomes accurately. Looking to the future, ABB has seized the opportunity to apply digital twin technology to improve its flowmeter products to meet process challenges, deliver value faster than ever before, and fulfill ever-increasing customer expectations.

⇒ ELECTROMAGNETIC FLOWMETERS

Production processes require reliable and accurate instrumentation to meet high-performance standards. For more than 40 years, ABB has been a reliable partner to the global water industry because of their dedication to product development, system solutions, and service. ABB's flowmeters are traditional workhorses in the production process industry because they are robust, reliable and, above all, accurate (Figure 1A).

Comprising a major share in ABB's

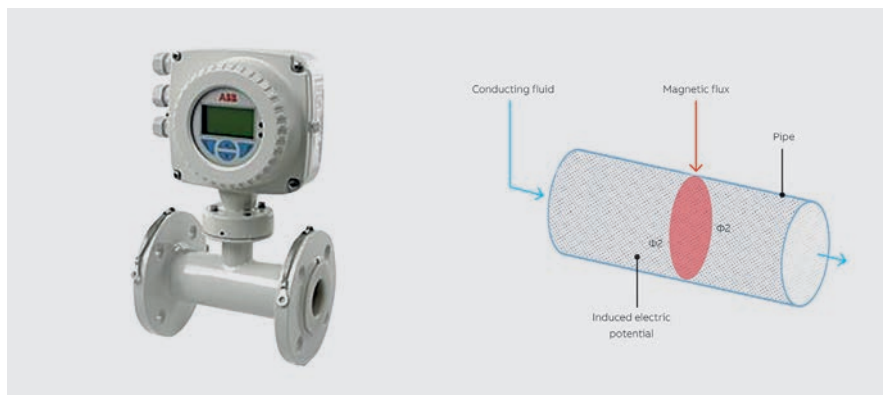

FIGURE 1. (A) ABB's EM flowmeter is shown. (B) Interaction of the magnetic flux with moving conductive fluid induces an electric potential (Φ_2) proportional to the fluid velocity $\Phi_1 - \Phi_2$.

flow measurement portfolio, EM flowmeters are especially appealing to customers who transport or process conductive liquids due to a unique set of advantages: simplicity of installation, negligible impact on pressure drop, and high accuracy. Furthermore, EM flowmeter performance is not susceptible to variations in temperature, pressure, or density, nor are they influenced by minor fluctuations in flow profiles. Independent of flow direction, with measurement errors contained within ± 0.2 percent over wide flow ranges, EM flowmeters enable accurate measurement at low flow rates.

ABB continually explores tools to improve their electromagnetic flowmeter offerings with the aim of meeting

high-performance standards and cost optimization demands. By combining deep knowledge of flowmeter physics with new verifiable modeling techniques, ABB endeavors to add value to existing flowmeters.

EM flowmeters rely on Faraday's law of electromagnetic induction to determine flow velocity. When a magnetic field is imposed within a pipe through which a conductive liquid, like water, flows, electric potential or electromotive force (EMF) is induced across the pipe cross section (Figure 1B). The EMF is proportional to the flow rate or velocity, and by measuring the induced EMF, flow rate can be estimated. The ratio of induced EMF to fluid velocity is sensitivity,

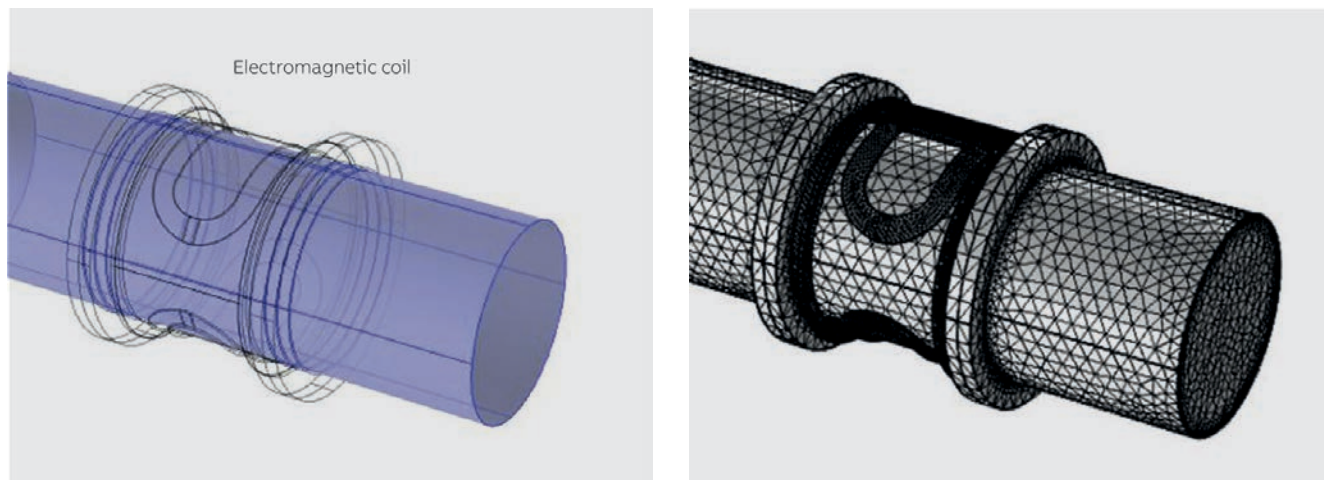

FIGURE 2. (A) Geometry of EM flowmeter built using CAD. (B) Discretized geometry for FEA calculations.

which is related to the calibration factor. While it is important to predict sensitivity, it is just as critical to predict the variations in sensitivity that result from changing conditions. Thermal and structural events that can impact flowmeter operation must be evaluated in the interest of product safety and to assess flowmeter performance under harsh conditions.

⇒ DIGITAL TWIN CONCEPT

What if one could develop a predictive model based on knowledge of physical processes that would predict flowmeter performance and minimize the need for testing? The result would be unparalleled productivity and heightened performance. ABB has developed a software model of an EM flowmeter based on a multiphysics finite element analysis (FEA) technique to accomplish this. This software model, or digital twin, is a replica that represents the physical asset in the virtual world, thereby mimicking the physical asset's real

behavior. Performance complexities can be understood, problems can be detected, and designs can be improved based on the resultant acquired process knowledge. This information can subsequently be used to build and operate the product in the field. Digital twins can simulate almost any condition in the virtual world with confidence that the same behavior would occur in the real world.

⇒ MULTIPHYSICS MODEL

FEA modeling involves discretizing the geometry of an object into smaller finite spaces. The computational model is supplied with information such as material properties as well as operating and boundary conditions. The model solves physics-based equations over the finite domains to derive parameters. This method, which yields three-dimensional and, if necessary, time-varying information, is employed for performance prediction and design

improvement of equipment across industries like oil and gas and aviation. The use of FEA modeling, as opposed to conventional testing methods, ensures that complex processes can be easily understood. Laboratory testing methods are limited by their dependence on the number and placement of sensors employed within the equipment, which is cost intensive and difficult for process industry applications to accomplish. In contrast, the recent advances and decreasing costs of high-performance

“ABB has developed a software model of an EM flowmeter based on a multiphysics finite element analysis (FEA) technique [to improve productivity and performance.]”

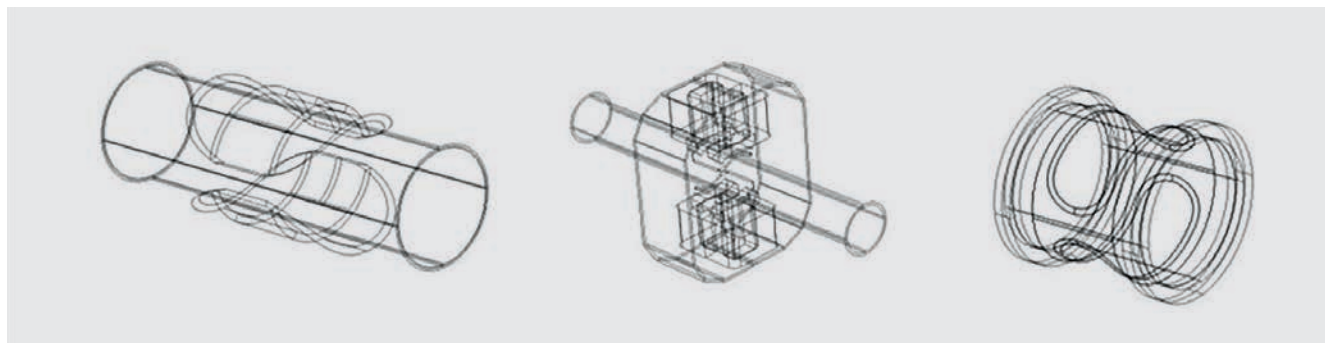

FIGURE 2. (C) Several varieties of flowmeters, differing in component design and/or size, were modeled.

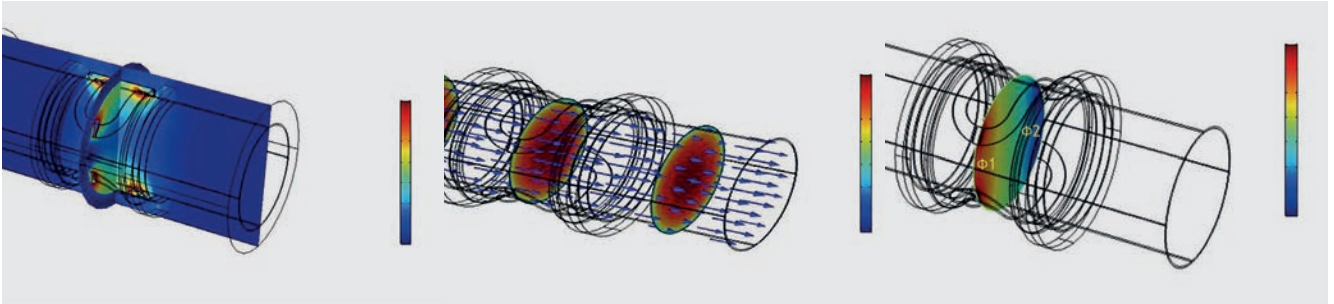

FIGURE 3. Qualitative physical phenomena were evaluated; red represents maximal values. (A) Magnetic flux distribution. (B) Fluid velocity contours. (C) Electric potential.

computing allows diverse and complex physics-based equations to be easily and iteratively solved using FEA.

ABB chose a multiphysics model of an EM flowmeter to improve their already outstanding flowmeter product offerings.

⇒ INTEGRATION OF PHYSICAL PHENOMENA

Initially, the geometry of a flowmeter was constructed using a CAD software (Figure 2A). The geometry, or the computational domain, was then discretized into minuscule elements across which equations were solved (Figure 2B). Several flowmeter samples of varying designs and sizes were modeled (Figure 2C).

The integration of the two primary phenomena, electromagnetism and fluid dynamics, and other diverse physical phenomena within a single model is challenging. Electromagnetism is analyzed by solving Maxwell's equations. These equations initially calculate the magnetic flux density within the computational domain (Figure 3A). The fluid dynamics is analyzed by solving equations of mass and momentum conservation for various flow conditions — simulating fluid flow through the pipe (Figure 3B). Next, the induced EMF, the result of magnetic flux and fluid velocity interaction, is calculated by integrating the magnetic and flow fields, using the Lorentz equations, derived from Faraday's law of electromagnetic induction (Figure 3C). The primary outcome is sensitivity, or the ratio of the induced EMF to the fluid velocity. To obtain a comprehensive picture, the model also solves for thermal propagation and structural dynamics parameters. Thermal and hydraulic stresses acting on the pipe wall are calculated (Figure 4). Such advanced simulations are essential to predict the

effect of challenging, harsh conditions on flowmeter health, like the impact of high-temperature and/or high-pressure liquids passing through the pipe. The ultimate result of these exhaustive calculations is a complete multiphysics model of the flowmeter that can predict performance as well as impending failure under adverse conditions.

Clearly, modeling has the benefit of minimizing the need for testing efforts, which are cost intensive and time consuming. Several ABB flowmeters, of unique design and varying line sizes, were successfully simulated in 2017. A comparison of the sensitivities calculated by the model and obtained during field tests revealed an agreement of 95 percent — establishing the model as a realistic and accurate predictive tool (Figure 5). Besides predicting sensitivity, the model could predict the linearity of the flowmeter or, in other words, the constancy of the sensitivity with changing flow rates — measurement accuracy. Not only is the digital twin concept an asset during the testing phase, but the model has also been extensively

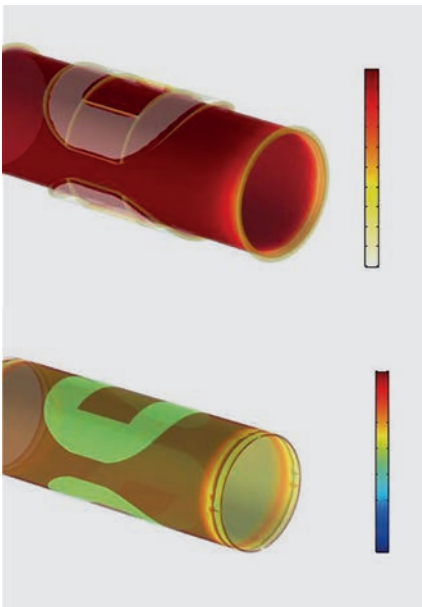

FIGURE 4. Qualitative thermal and hydraulic stress fields are illustrated; red represents a maximal value. (A) Temperature field. (B) Stress field.

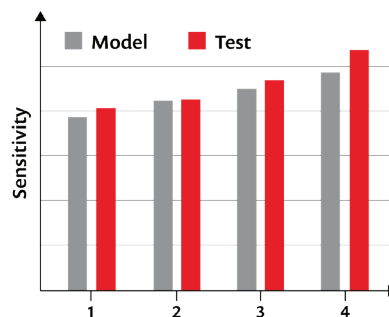

FIGURE 5. Several flowmeter varieties were modeled and compared with test data.

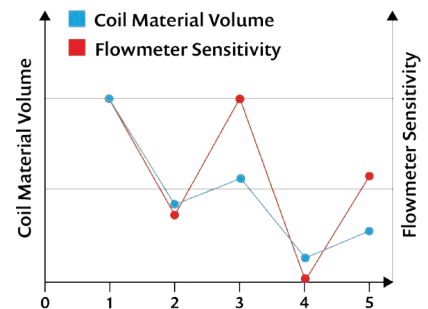

FIGURE 6. Iterative modeling performed for optimal coil design.

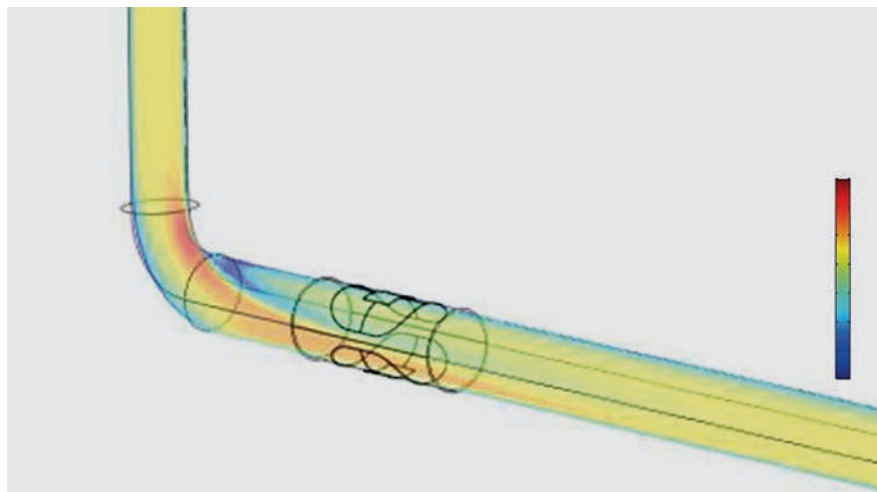

FIGURE 7. Modeling an EM flowmeter installed in a customer piping system to predict field performance under distorted flow conditions.

leveraged to modify the existing design of the flowmeter to improve quality. By incorporating novel component designs and innovative ideas into the model, improvement in flowmeter performance could be evaluated.

The modified flowmeter was found to outperform the existing flowmeter product better than the current flowmeter — setting the stage for future design improvements. The digital twin, when applied to flowmeter development efforts, will increase flowmeter sensitivity, improve measurement accuracy, and reduce manufacturing costs. Extensive efforts are currently underway to test prototypes of the flowmeter and incorporate the various design modifications and evaluate the feasibility of some of the novel ideas.

⇒ DOING LESS CREATES MORE

The primary goal of product development is to minimize material usage while maintaining or maximizing the performance level. Accordingly, the digital twin model has been used to optimize the

“Digital twins can reliably simulate almost any condition in the virtual world with confidence that the same behavior would occur in the real world.”

design of flowmeter components with the intent of reducing material costs.

Being an important component, the EM coil was modified to obtain the optimal size and/or shape for the ultimate flowmeter performance. Size variation of a given coil was evaluated in a series of iterations (Figure 6). In a particular iteration, the original sensitivity of the flowmeter could be maintained using significantly less copper coil material. Furthermore, simulations of radically novel coil designs were shown to reduce the amount of material needed to maintain the original performance level. This is of particular value for the development of large flowmeters because coil costs can make up a substantial portion of the total flowmeter material costs. Recently, proposed solutions to reduce the overall flowmeter footprint for large flowmeters have been evaluated and verified in the subsequent prototype testing phase.

⇒ REPLICATING FIELD CONDITIONS

While development and testing are important phases in the product life cycle, the installation phase has its unique challenges too, given that system features like bends and valves can distort flow profiles and impair measurement accuracy. Understanding the systemic effect of piping features on flowmeter performance is therefore crucial. ABB’s flowmeter digital twin was expanded to include a

customer piping system (Figure 7).

The effect of flow modification on measurement accuracy was studied to provide insight into the impact of system features such as upstream bends. As a result, ABB could determine the best location to install flowmeters within a given piping system, thereby enabling the correction of flowmeter readings for an installed flowmeter.

To date, the tool has demonstrated veracity in predicting flowmeter performance and enabled engineers to improve the design of flowmeters. The expansion of the model to simulate the manner in which flowmeter operations influence the flow profiles of customer piping systems also opens up new avenues for the improvement of measurement accuracy. The digital twin technology can also be employed to serve as a useful guide for flowmeter installation in the field, which enabled industries like water management facilities to improve their flow control systems in the interest of radically enhancing industrial process performance.

Extensive research at ABB concentrates on developing the digital twin model for use in other process industries to provide customers with the most advanced digital means of reaching unparalleled productivity and performance. ABB focuses on maximizing value and producing products with fewer defects, ensuring optimal operation, bringing products quickly to market, and improving operation. ❖



Subhashish Dasgupta,
ABB
Corporate
Research,
Bangalore,
India



Vinay Kariwala,
ABB BU
Measurement
& Analytics,
Bangalore,
India

Inspiring Young Engineers to Design for the Future at EPFL

EPFLoop, one of the top three teams invited to the SpaceX Hyperloop Pod Competition, used multiphysics simulation to hit the ground running with a unique design advantage.

by **BRIANNE CHRISTOPHER**

Over the course of the annual SpaceX Hyperloop Pod Competition, engineering teams work to design and build hyperloop pods. The ultimate goal of the hyperloop concept is to achieve a mode of transportation that is high speed, intercontinental, and self-propelled. Such a system would both revolutionize the experience of transportation and offer a greener alternative to other modes of travel.

The Hyperloop Pod Competition, which started in 2015 as the brainchild of Elon Musk, culminates with a weeklong competition each summer in Hawthorne, California, located in southwestern Los Angeles. Over the course of the competition week, participants get to test their hyperloop pod designs on a mile-long track (Figure 1) at speeds of approximately 500 km per hour.

⇒ WORKING ALONGSIDE THE WORLD'S TOP ENGINEERS

Each year, the top 20 teams worldwide are invited to the California testing facility, and the top three teams can run on the track under vacuum at the final event. As a first-time competitor, EPFLoop exceeded all expectations by making a presence in the finale as one of the three teams to run in vacuum that year. Even more impressive was the fact that they classified first at the end of the testing week and were told that their pod showed the highest design reliability. Overall, the EPFLoop team ended up placing third in the high-speed run on the final day of the competition due to the unexpected presence of dust on the test track, which affected their pod's performance. Their experience at SpaceX proved to be invaluable for many reasons.

Made up of engineering students and technical advisors, the EPFLoop competition team formed at the Swiss Federal Institute of Technology Lausanne (EPFL). Dr. Mario Paolone, principal advisor of the EPFLoop team, says that the Hyperloop Pod Competition is a "chance for students and young engineers to participate in a state-of-the-art challenge, with some of the



FIGURE 1. An inside view of the hyperloop test track.



FIGURE 2. The EPFLoop hyperloop pod design.

world's top engineers." Besides the chance to use high-tech testing equipment and rub elbows with professional engineers, the experience is a great opportunity for students to learn the importance of researching energy-efficient modes of transportation. It also gets students excited about research and inspires them to pursue careers in engineering.

⇒ SIMULATING THE HYPERLOOP POD

Aside from the opportunity to visit SpaceX and experience an advanced testing facility, the students who participate in EPFLoop have something more to gain: valuable experience using multiphysics simulation. Each aspect of EPFLoop's hyperloop pod design (Figure 2) involves modeling and simulation. In fact, Paolone calls simulation the "core" of their project. One obvious reason: The team's 60-meter test track is nowhere close

to the mile-long test track at SpaceX. Consequently, even if their tests confirmed the results of the simulations at low speeds, they still relied on simulation software to gain insight into what will happen at very high speeds. "Every single component of the pod has to be simulated and validated," says Dr. Lorenzo Benedetti, the technical leader of EPFLoop.

Using the COMSOL Multiphysics® software, the EPFLoop team was able to analyze the complex components of their hyperloop pod and predict its performance before ever setting foot on the SpaceX premises. Furthermore, the team needed to be able to look at multiple physical effects at once, including mechanical, fluid, electrical, and materials science phenomena. "This project is inherently multidisciplinary," says Benedetti. For example, the design team wanted

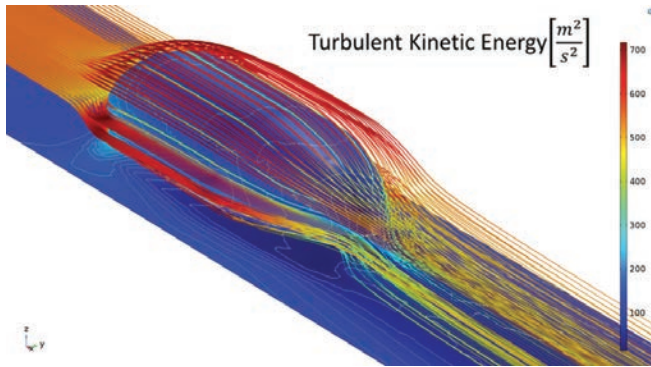

FIGURE 3. The turbulent kinetic energy around the hyperloop's composite aeroshell structure.

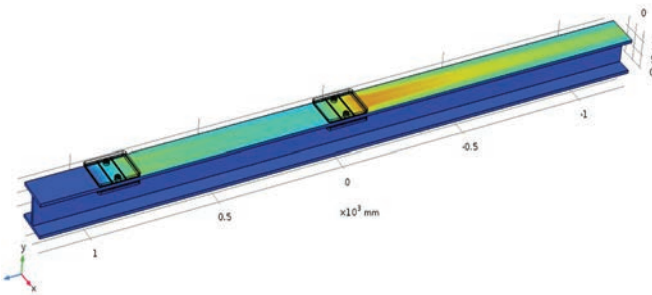

FIGURE 4. The temperature profile in the hyperloop's braking system.

to see how the pod's aeroshell, made out of a lightweight composite carbon fiber, would fare on the test track. To minimize the aerodynamic resistance of the shell, they performed a computational fluid dynamics (CFD) analysis coupled with shape optimization and mechanical stress studies (Figure 3).

The aeroshell had to be both lightweight and able to withstand aerodynamic forces during acceleration and deceleration. The team used the High Mach Number Flow interface to find the lift and drag coefficients of the pod. The pressure distribution results from the CFD analysis were then used to find an optimized aerodynamic shape via the LiveLink™ for MATLAB® interfacing product.

The team also needed to see how the pod's pressure vessel would perform in the tube, under vacuum, during the high-speed run. They designed vacuum-proof enclosures, which are responsible for storing the batteries and electrical components of the pod. In fact, some electronics cannot sustain vacuum conditions, and a subpar design could cause the inner components to be directly exposed to the track — which is essentially a vacuum tube — and destruct. The team performed a structural analysis of the vessel's design, a composite pressure vessel, using the Shell interface in the COMSOL® software to account for the superposition of layers. They then optimized the structural response to be able to have the minimum weight possible. The Tsai-Wu safety factor and principal stresses were then studied in the optimized pod design.

⇒ SLIDING TO A STOP

The hyperloop's braking system is another example of multiphysics design. The brakes need to be able to safely slow the pod down

after it has reached its top speed. However, there is an extreme temperature increase in the braking system due to the vacuum conditions in the tube: Without air, there is no convective dissipation of heat to the air and the heat remains stored in the brake pads.

To ensure that the braking components would perform as expected, the EPFLoop team coupled heat transfer and mechanical simulations for their brake system design (Figure 4).

Using the Heat Transfer in Solids interface, the team analyzed the temperature profile in the brake system during and after braking to ensure that it would not become hot enough to cause damage to the hyperloop pod. They then used the Translational Motion feature to estimate the power dissipation caused by the friction, and therefore, the temperature rise in the brakes. Using this information, the team performed a material sweep of the different brake pad options, including ones made out of leather, thermoplastic polyurethane, plaster, and some more classical braking pad materials used in the automotive industry. The simulation analysis helped the team to identify that a customized material created for them by an external company was the

best material option for the brake pads because it kept the braking system within the desired temperature range.

The team's detailed simulation work paid off: "One of the judges called our approach 'extremely compelling'," says Benedetti.

⇒ LIFE-SHAPING EXPERIENCES

The most impressive aspect of EPFLoop is not their pod design or competition ranking, but the project's impact on the students who participated. Nicolò Riva, a PhD student at EPFL who also heads the team's aerodynamics group, said that the experience made him "want to stay in academia and participate in similar projects." Zsófia Sajó, another student involved in the 2018 competition team, said that EPFLoop inspired her to "do something about solar power and clean energy for transportation."

Paolone's impression of the project echoes the takeaways of his team members. He said that students set aside their personal and free time to participate in EPFLoop with motivation, drive, and commitment. "We need these kinds of people," he said, to be engaged in designing clean modes of transportation for the future. ❖



The EPFLoop team.

VIRTUALLY OPTIMIZING METASURFACE TOPOLOGY WITH A GENETIC ALGORITHM

An optimization algorithm inspired by natural selection is used to determine the best design configuration for the metasurface of an optical antenna.

by SARAH FIELDS

Often in engineering, we look to the natural world to find inspiration for new ways to approach our design problems. Whether we are taking inspiration from fluid flow around wings to inform a system for cooling devices, studying slug slime to invent better medical adhesives, or designing the nose of a bullet train to resemble the beak of a bird, nature holds the key to even the most elusive design solutions.

At its essence, optimization involves minimizing a loss function by systematically selecting input values from within a set of parameters governing the system under study. It is unsurprising that even in the mathematics-dense world of the optimization of electromagnetic metasurfaces, nature has something to say.

Bryan Adomanis of the Air Force Institute of Technology (AFIT) was interested in creating a pixelated grid antenna that would function as a 3D Huygens source; that is, a 3D, metal, nanoparticle-based optical antenna capable of propagating only in a specified direction while maintaining the desired amplitude and phase delay. In the development of such an antenna, the geometry of the metasurface is the primary driver of the

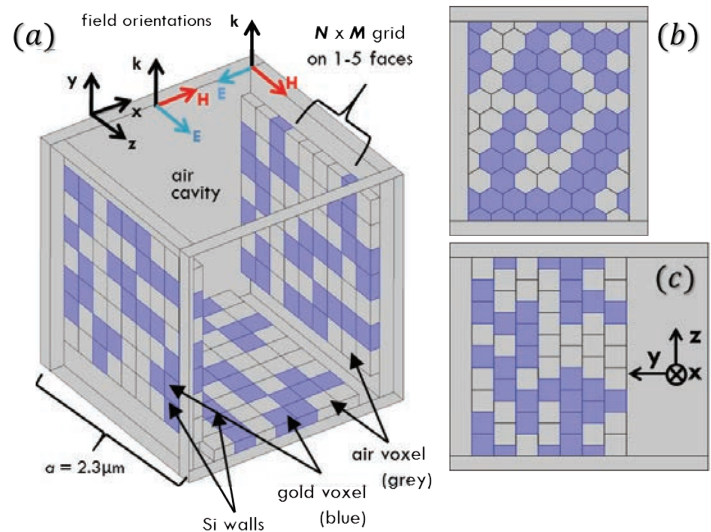

FIGURE 1. Sample voxel and cavity geometries, which can be used for the genetic algorithm.

“Due to the nonlinear nature of the problem and the large parameter space, other optimization methods were insufficient — They were either too computationally intensive or could not be trusted to find the global minimum. In this context, genetic algorithms get the job done.”

— BRYAN ADOMANIS, AIR FORCE INSTITUTE OF TECHNOLOGY

electromagnetic response. As such, by optimizing the geometry of a “blank slate” — this grid of 3D pixels (voxels) — it is possible to find the best design, which would possess a high forward scattering and minimal backscattering.

The challenge in designing this antenna is the large design space: A voxel can exist as either gold or air, and

there are so many possible geometrical configurations for the antenna that it was unclear how to identify the best design. For even the lowest-resolution design, 2^{40} (over 1 trillion) unique models could be generated (Figure 1). Gold and air voxels (cubes) are represented in blue and gray, respectively. Using a genetic algorithm (GA) routine, the COMSOL® software finds the

best solution, or arrangement of voxels, in about 2000–4000 models. Also, there was no identifiable correlation among patterns of geometry and performance (transmittance and phase), and as such, no function to minimize. Therefore, a COMSOL model was implemented to efficiently solve these highly nonanalytical models.

Essentially, this pixelated grid antenna is a scattering unit cell, where the walls can be populated with dielectric and metal as needed. In selecting the best geometry for metal, nanoparticle-based antenna out of nearly one trillion possible configurations, a routine inspired by biological reproduction and natural selection was the answer.

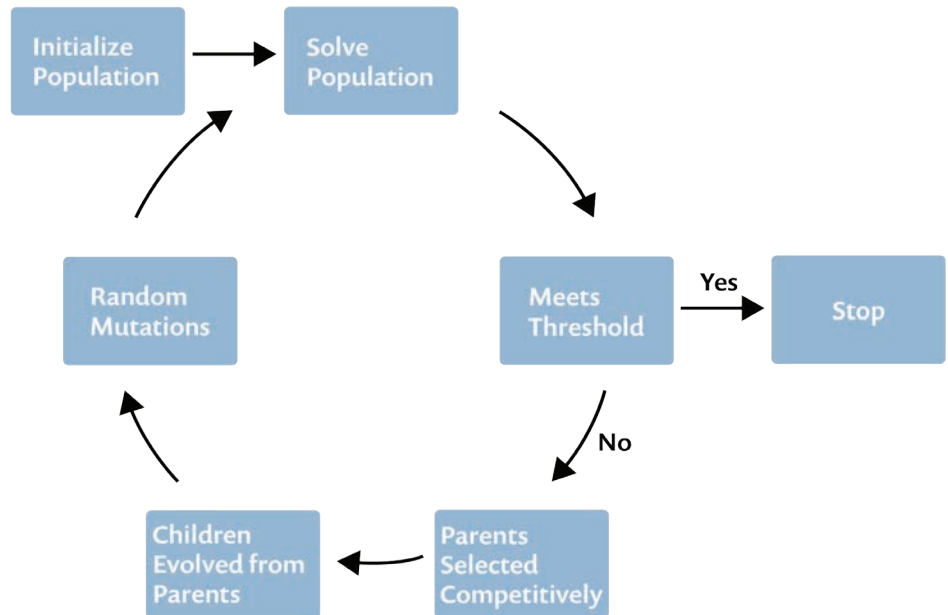

FIGURE 2. Genetic algorithm solution steps.

⇒ GENETIC ALGORITHM ROUTINE

“Due to the nonlinear nature of the problem and the large parameter space, other optimization methods were insufficient — They were either too computationally intensive, or could not be trusted to find the global minimum. In this context, genetic algorithms get the job done,” Adomanis explains.

In a genetic algorithm (Figure 2), a design parameter, what can be thought of as the gene, exists within a group of design parameters, or the chromosome. Each group of design parameters represents a unique design, or what can be thought of as the individual, with all unique designs forming a total population. The fitness of each individual in the population is scored, which informs the likelihood of the individual becoming a parent to an individual in the next generation.

“We have high confidence that our design is working properly, since we have composed a properly functioning, full-scale simulated lens using the results of each individual element in that model.”

— BRYAN ADOMANIS, AIR FORCE INSTITUTE OF TECHNOLOGY

In his implementation of a genetic algorithm, Adomanis initializes the population with individuals representing different voxel arrangements or antenna designs. He used MATLAB® to create the population, generated its binary representation or “mask,” which enters the GA routine for each set of

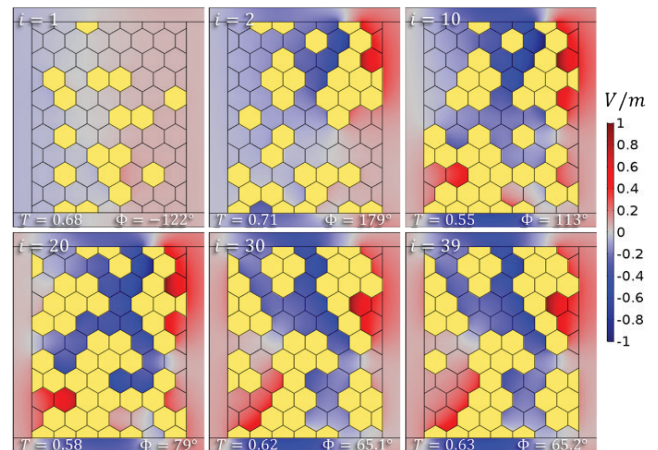

FIGURE 3. Simulation results showing the magnetic field (scaled in terms of V/m) resulting from the optical antenna in intermediate steps of optimization. As the topology forms, so do strong magnetic modes.

unique parameters; and feed it to the COMSOL model.

He then used multiphysics simulation to evaluate the fitness of each individual, or unique design, within the population, or set of unique designs. An individual is fit when a fitness threshold representing the desired

scattering is met. After the fitness of the individuals, or unique models, in the population, or set of unique models, is computed, individuals who do not meet the threshold are removed from the routine. The next generation of models, or “children,” is then populated

from the unique models that met the fitness threshold and formed by “crossovers,” where substrings of two binary representations are concatenated in a child, and “mutations,” where a bit within the binary string is switched. Adomanis integrated MATLAB® with COMSOL Multiphysics® through the add-on product LiveLink™ for MATLAB®.

⇒ CONVERGING ON THE BEST DESIGN

To identify the best topology for the metasurface of the optical antenna, Adomanis needed to optimize the phase delay of a total field transmittance in a given direction while maintaining the amplitude. The electromagnetics modeling capabilities were used for this purpose, allowing him to set his GA routine to go through many sets of voxel configurations and compute the resulting electromagnetic radiation without needing to dive too far into the complexity of the physics. Figure 3 shows the magnetic field resulting from the antenna in various stages of optimization.

As the individuals of a generation are evaluated, parents are selected, the child generation populated, and the individuals of the child generation evaluated, the routine continues, and the population shifts toward the best design (Figure 4). Using the genetic algorithm routine, the COMSOL® software generated the best design in a few thousand models, compared to a parameter space of approximately one trillion possible designs.

With this routine, Adomanis could maximize transmittance at various phase values. Within 30 generations,

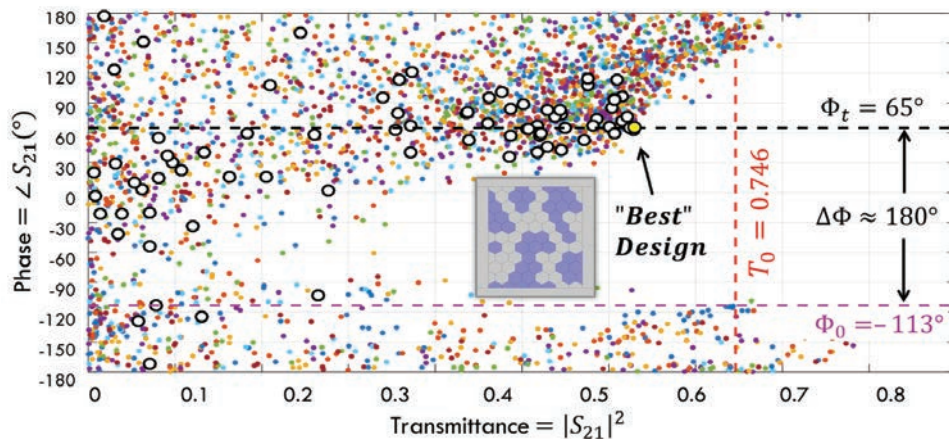

FIGURE 4. Plot of the transmittance, or the scattering parameter $|S_{21}|^2$, against the phase. Generations are distinguished with color.

the unique designs of the population began to meet his performance criteria (Figure 5).

Visualizing the performance in a multiobjective solution space allowed Adomanis to select a design based on the criteria that is most important for a specific application. In one design, he might prioritize the highest transmittance, while in another design, he might want to prioritize accuracy in the phase delay.

Adomanis was able to successfully generate the colocalized electric and magnetic dipoles from a pixelated grid that produces a total field only in the forward direction, with little backward scattering. By combining a GA routine with electromagnetics simulation, he could generate an optical antenna that functions across the entire 2π phase space. An example is shown in Figure 5. “This work represents the first time that the topology of a pixelated grid antenna has been optimized with a genetic algorithm in 3D,” Adomanis comments.

⇒ LEADING DESIGN BECOMES REALITY

After Adomanis determines the best design from the GA routine, his next challenge is creating a real-world prototype based on the optimized design. However, because the smallest features of the optical antennas are about 100 nanometers, a specialized, newly developed fabrication process was necessary to implement the concept.

To accomplish this, Adomanis is collaborating with a research team at Sandia National Laboratory that has the capability to print the antenna. He simply provides the group with the optimized pixelated grid that resulted in optimal scattering in his simulation. “We have high confidence that our design is working properly, since we have composed a properly functioning, full-scale simulated lens using the results of each individual element in that model.” Adomanis concludes, “Being able to use COMSOL for computing the performance of the antenna was powerful, as we could focus on implementing the GA routine to optimize the design instead of the details of the electromagnetics computation of an arbitrary array of voxels.” ❖

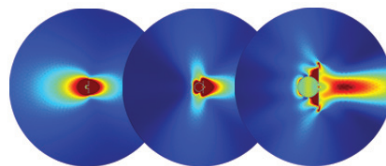

FIGURE 5. Genetic algorithm optimization of the geometry of an optical scatterer called the omega particle. The aim is to design a scatterer with, from left to right, maximum forward scattering and minimal backward scattering.



Bryan Adomanis, Air Force Institute of Technology

COMPLEX FENESTRATION SYSTEM FOR ENERGY EFFICIENCY

Scientists at Eurac Research are using simulation to improve the energy efficiency of buildings and enhance visual and thermal comfort for people.

by **JENNIFER HAND**

Energy efficiency can save money for the operators, improve comfort for occupants, and reduce environmental impact, so it is a key consideration for any building and fenestration, the term applied to any opening in a building envelope. Components such as the frames, glass and shading attachments of windows, and doors and skylights make a significant contribution to energy efficiency. By controlling direct sunlight and heat gain, they minimize glare; distribute daylight comfortably; and reduce demand for heating, cooling, and artificial light.

The interplay of fenestration components can, however, have an unexpected influence, and this is not fully covered by ISO 15099:2003, which gives calculation procedures for determining the thermal and optical transmission properties of window and door systems. The standard does not, for instance, account for characteristics such as the complex geometry of shading systems or particular types of applied coatings, such as highly reflective ones.

“The main problem is that the standard method of calculation treats any shading system (for example, a blind that sits between two glass panes) as a parallel layer and not a 3D structure,” explains Ingrid Demanega, junior researcher at Eurac Research in Bolzano, Northern Italy. “The slats of a blind are regarded as simple 1D openings through which air flows, even if the slats are curved as they are in a Venetian blind, and convective

heat transfer is measured only in terms of pressure drop. The slats are also assumed to be ideal diffuse surfaces. This approach affects the accuracy of both the optical and thermal modeling” (Figure 1).

Led by Demanega, a team at Eurac Research, in collaboration with the research groups in building physics at the Free University of Bozen-Bolzano, set out to identify limits in the current approach to modeling and define a new approach by comparing simulation results with the physical testing of a commercial fenestration system installed at the Living Labs of the Free University of Bozen-Bolzano (Figure 2).

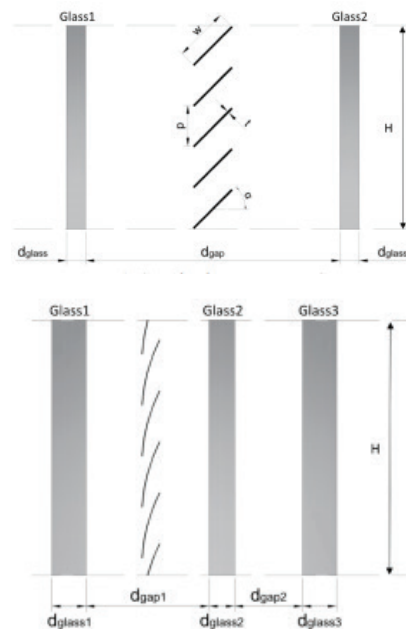

FIGURE 1. Standard (top) and complex (bottom) fenestration system.

⇒ CREATING A NEW OPTICAL MODEL

The on-site fenestration installation that the team set out to simulate is a triple-glazed system incorporating two sealed cavities with an integrated blind in the external cavity. This blind has curved slats that have a highly reflective coating designed to block solar radiation and provide comfort for people inside the



FIGURE 2. Setup at the Living Labs of the Free University of Bozen-Bolzano, including two heat flux plates, an in situ device designed by the University of Innsbruck to measure the overall heat flux, and several thermocouples for the surface and air temperature measurement.

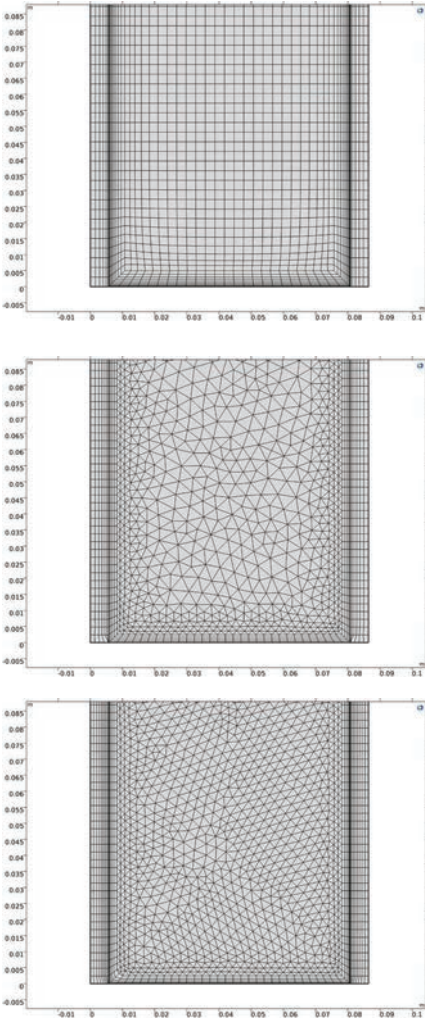

FIGURE 3. Mesh typologies for standard fenestration system without blinds: normal structured (top), coarser unstructured (middle), and normal unstructured (bottom).

building. The first step was to employ optical modeling to calculate the amount of solar radiation absorbed by the installation.

The main fenestration simulation tools, such as Window7, are based on ISO 15099 and the radiosity approach; however, it is possible to modify this by adding more detailed modeling data. Working with Radiance, the Eurac team used data based on the bidirectional scattering distribution function. This function describes how a solar ray splits and how its intensity changes as it passes through a surface so that it can be applied to complex geometries and highly reflective surfaces. Through ray tracing plus analysis of each pane of glass and each shading component, the team calculated the total amount of solar

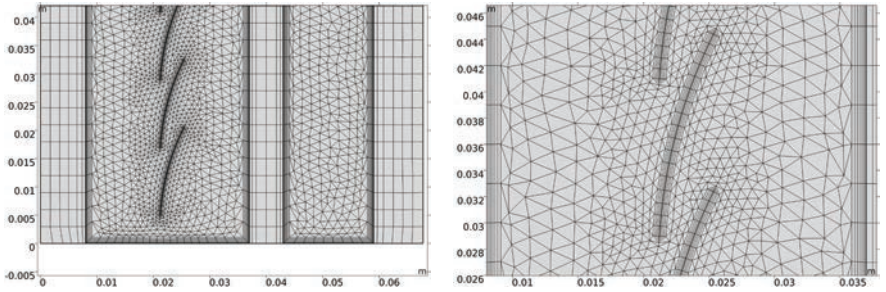

FIGURE 4. From left to right – glass pane, cavity containing blind, second glass pane, second cavity containing argon and air only, and third glass pane. In this case, the two cavities are sealed, not ventilated. Close-up image of the mesh around the blind and near the edges of the cavity.

radiation absorbed by the glazing system.

⇒ MODELING HEAT FLUX AND FLUID FLOW

The absorbed fraction of solar irradiance was then transferred into COMSOL Multiphysics® for comprehensive thermal modeling. Demanega performed a mesh sensitivity analysis by modeling the fenestration system installed locally (Figure 3). In the preanalysis, she used the Boussinesq approximation and considered both incompressible flow with the Boussinesq approximation and compressible flow. “I noticed that, simulation time was much longer for a compressible fluid, but the results were similar, so I decided to use incompressible fluid,” she explains.

To calculate radiation exchange, Demanega used the surface-to-surface (radiosity) method for long-wave radiation. She also created two radiation groups: one for the internal walls and blinds of the first cavity and another for all of the internal walls of the second cavity.

“After considering different approaches, I selected solving the fluid flow problem using the k-epsilon turbulence model with a low Reynolds number wall treatment. This led to a robust simulation with accurate results.”

Using a triangular mesh in the center and a rectangular, mapped mesh at the boundaries, Demanega finalized the settings. “I altered the size until I could find no further improvement. In the end, the mesh was more or less 20,000 elements” (Figure 4).

⇒ SIMULATING STATIONARY CONDITIONS

Following standard National Fenestration Rating Council (NFRC)

“The validation of a technique using Radiance and COMSOL® means that the Eurac Research team now has a very useful tool to accurately assess the temperature of components and the heat flow through a complex fenestration system.”

stationary boundary conditions for summer, the outside temperature was set at 32°C/89.6°F, with 24°C/75.2°F inside and a solar radiance of 783 W/m². The integrated blind was modeled in three separate positions: completely closed (75° angle), almost fully open (18°), and halfway between (37°) (Figure 5).

The team members performed two types of simulation. They used Radiance for optical modeling to calculate the absorbed fraction of solar irradiance, then COMSOL Multiphysics for heat transfer and fluid flow; they also followed the standard method using Window7 with ISO 15099 calculations.

As a control, the team also modeled a standard fenestration system with and without a blind using stationary conditions. Simulation results showed clear correspondence between the two approaches for the system without a blind and nearly perfect correspondence for a standard system with a blind.

⇒ TIME-DEPENDENT CONDITIONS

For simulation of dynamic behavior, the team used data from the local weather station for input to the optical simulation and measured the surface temperatures of internal and external glazing as boundary conditions for the CFD simulation. These boundary conditions were implemented in COMSOL Multiphysics by importing a dataset with discrete temperature values and time steps of 300 seconds. These values were then interpolated with a polynomial function and assigned to the proper glazing faces. Simulation of heat flux on the internal surface of the window system was compared with measured heat flux on the same surface (Figure 6).

"We were very pleased to find correspondence between our simulation results and physical measurements for the blinds in a fully closed position, especially because conducting the simulation in two different environments meant that there was potential to fail in one or the other," comments Demanega.

⇒ A VERY USEFUL TOOL

The validation of a technique using Radiance and COMSOL® means that the Eurac Research team now has a very useful tool to accurately assess the temperature of components and the heat flow through a complex fenestration system.

According to Demanega, the results show the value of detailed optical modeling to understand primary solar radiation before thermal modeling in order to measure secondary heat gain caused by the absorption and re-emission of radiation.

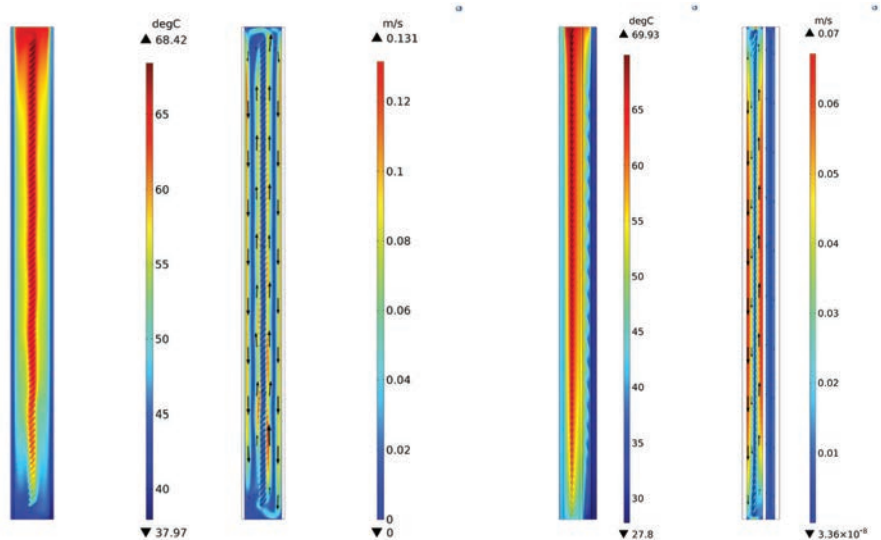

FIGURE 5. CFD results show how convection affects the temperature of a window in a standard (left) and complex (right) fenestration system.

"In particular, the standard approach does not account for the vertical distribution of temperature. It is important to learn more about the distribution of temperature from top to bottom of a cavity, pane of glass, and blind because component temperature influences both the structural integrity of a building facade and the comfort of people within."

With the knowledge gained, the team is now validating the approach for different blind positions and is looking forward to applying the approach to naturally ventilated cavities containing integrated blinds, often found in double-skin facades. The team is also looking at how to disseminate this information within the construction industry and is considering the feasibility of a simulation application that would enable modeling of complex

fenestration systems to be more widely available to professionals. ❖

ACKNOWLEDGEMENT

This study has been developed in the framework of the research activities of the project FACCamp n. ITAT1039, funded by European Regional Development Fund and Interreg ITA AUT programme and the project "IBAS — Intelligent Building Automation System for optimization of energy consumptions and indoor environmental quality" of the Free University of Bozen-Bolzano.



Ingrid Demanega, Junior Researcher, Eurac Research

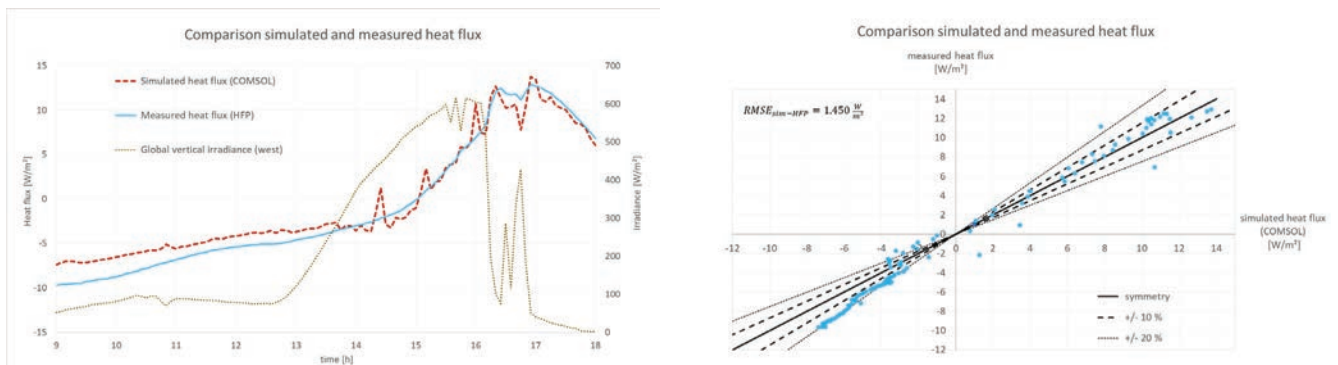

FIGURE 6. Correspondence between the time-dependent simulation of the commercial system at Free University of Bozen-Bolzano and physical measurements of heat flux on the internal side over the total height of window.

Adding Quantitative Systems Pharmacology to the Pharmaceutical Sciences Curriculum

The University of Oklahoma College of Pharmacy is teaching PhD students in pharmaceutical sciences how to create multiscale models in order to analyze drug disposition within the human body.

by **BRIDGET PAULUS**

Optimizing drug dosages, evaluating side effects, improving clinical trials, and reducing costs and time to market — these are just a few of the benefits of model-informed drug development. Due to these advantages, the United States Food and Drug Administration (FDA) is encouraging pharmaceutical companies to include simulation in their product development cycles. There is just one problem: Companies often have a hard time finding candidates with strong experience in simulation, as mathematical modeling is minimal in most pharmaceutical sciences programs.

To address this issue, the Institute of Quantitative Systems Pharmacology and the College of Pharmacy at the University of Oklahoma Health Sciences Center partnered in 2014 to develop an innovative curriculum. Within this program, Research Assistant Professor Roberto A. Abbiati designed a PhD-level course on simulation for pharmaceutical sciences students at the University of Oklahoma College of Pharmacy. The class gives an overview of numerical analysis and the modeling workflow in the COMSOL Multiphysics® software. Students learn how to apply modeling to pharmacokinetics, the branch of pharmacology that studies the effect of the human body on the administered drugs. Specifically, Abbiati applies modeling to streamline the quantification of drug concentration levels in the human body and the intended target sites over time — an important concern when developing potentially life-saving treatments.

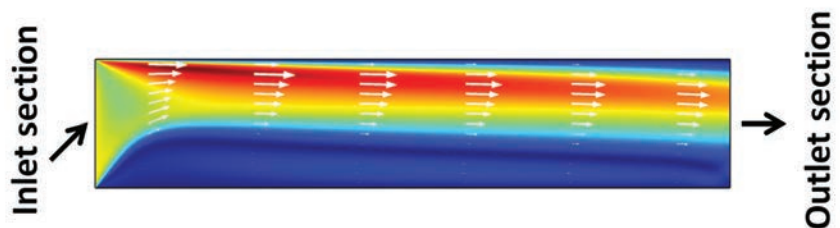

FIGURE 1. Velocity map for laminar fluid flow in a channel.

⇒ TEACHING MODELING TO THE NEXT GENERATION OF PHARMACEUTICAL SCIENTISTS

Pharmaceutical sciences students learn about a wide variety of subjects, but simulation is not typically one of them. According to Abbiati, this is a problem: "Besides being a desired skill by companies, modeling and simulation help design better experiments," he says.

Abbiati's courses are designed to teach PhD students in pharmaceutical sciences how to take advantage of simulation software in their work. The course starts students off with the MATLAB® software, which serves as a bridge to other kinds of mathematical modeling software. As the course continues, Abbiati and his students delve into numerical analysis and the finite element method.

Eventually, students learn how to build models in COMSOL Multiphysics. Abbiati takes them through each step of the modeling workflow. Students learn how to build geometries (starting in 2D, like the laminar flow example in Figure 1); set up the physics; determine the best mesh for a model (Figure 2); and postprocess the results (Figure 3).

Throughout the course, the class learns how to create both compartmental and multiscale models. The former is the standard for pharmacokinetic applications and is an easier concept to understand. Abbiati says that a standard compartmental model "assumes the human body is like a box, with one flux in and one flux out." Using ordinary differential equations, compartmental modeling is a simple way to determine the drug concentration in the human body over time. There is a major limitation with this type of model, though. Abbiati says, "It cannot determine where the drug is localized within specific tissues, which is a critical limitation in several applications including cancer treatment."

"I'm using COMSOL® to understand why and how the physical structure of the tumor is a barrier for the delivery of the drug."

— **ROBERTO A. ABBIATI, ASSISTANT PROFESSOR, UNIVERSITY OF OKLAHOMA HEALTH SCIENCES CENTER**

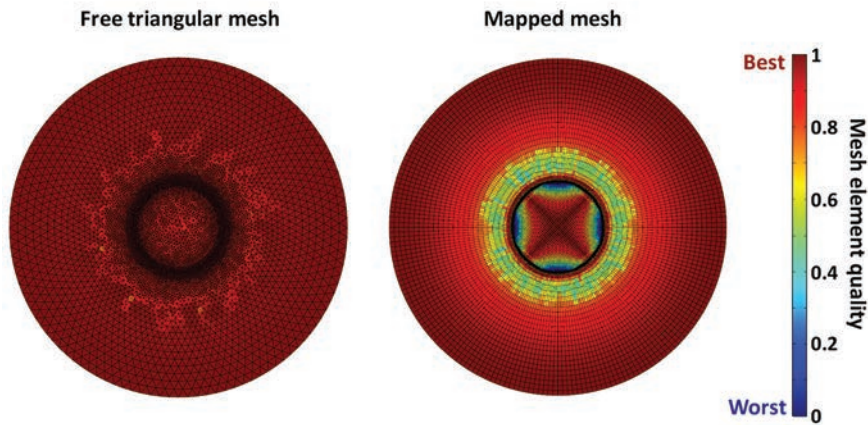

FIGURE 2. Mesh comparison used to introduce students to various mesh options.

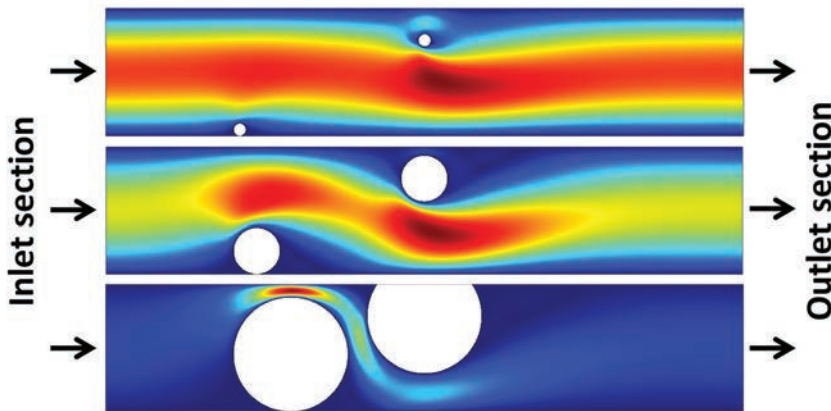

FIGURE 3. Velocity pattern for laminar fluid flow in a channel with obstacles of different sizes, an example from Abbiati's course.

Enter multiscale modeling. While it requires a more detailed understanding of physiological and biological processes compared to compartmental modeling, multiscale modeling is able to provide valuable insight into how deep a drug can penetrate a certain tissue or organ. This type of simulation involves accounting for size scales ranging from the entire human body, individual organs, single cells, down to the molecular level. Although it sounds like a complex subject, Abbiati demonstrates a step-by-step approach that is easier for the students to learn.

⇒ GAINING INSIGHT INTO TUMOR TREATMENT

Dr. Abbiati highlighted the benefits of multiscale modeling for pharmacokinetics by sharing some of his

own research performed with his team at the Institute of Quantitative Systems Pharmacology. He is currently studying how drugs interact with solid tumors.

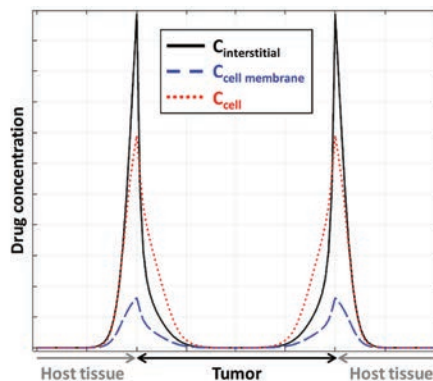

FIGURE 4. The drug concentration profile in a tumor.

These drugs, which typically travel via the bloodstream, can have a hard time getting into tumors. The issue is that these types of masses have "physical barriers that limit drug delivery," explained Abbiati. Tumor sites often have high pressure, which makes it difficult for the drug to penetrate them, for instance.

"I'm using COMSOL® to understand why and how the physical structure of the tumor is a barrier for the delivery of the drug," says Abbiati. To gain such insight, he uses multiphysics simulation to model blood flow in microvascular vessels, drug transport within the tumor interstitial space, and drug interaction with tumor cells. Abbiati modeled how the fluid moves according to the pressure gradient within a tumor mass, assuming that the fluid carries the drug with it. He then used the Transport of Diluted Species interface to describe the drug concentration.

Abbiati said that he was able to use this model "to determine how deep the drug penetrates the tumor, depending on changes in its physical structure over time" (Figure 4). The advantage of using multiphysics analysis was that he could "describe where the drug is located at any given time and any given location of the tumor." From his research, it is clear that multiscale modeling is a useful tool for pharmacokinetics, enabling researchers to better understand how drug concentrations are affected by the human body.

By teaching simulation in his PhD-level pharmaceutical sciences courses, Abbiati is giving students a valuable skill for drug research that could greatly improve future drug development processes. Aside from that, because these students will graduate with a simulation background, they are more attractive to pharmaceutical companies when they are ready to enter the workforce. ♦

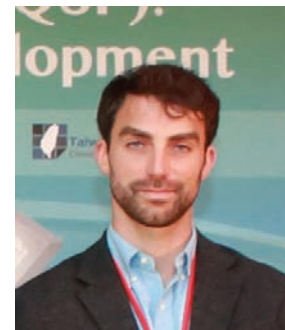

Roberto A. Abbiati, Assistant Professor, University of Oklahoma Health Sciences Center

SEISMIC SAFETY EVALUATIONS OF DAMS WITH NUMERICAL SIMULATION

Researchers at Pisa University are using numerical simulation to investigate the accuracy and soundness of dam safety evaluations during earthquakes and other seismic events.

by **GEMMA CHURCH**

Structural integrity and adherence to code requirements are paramount in the development of all types of large constructions and buildings. Numerical simulation can be of great help but is only as good as the assumptions that go into the mathematical model, and when it comes to the seismic safety evaluation of dams, there is a growing demand for a more rigorous approach. The failure of large structures poses serious safety concerns and often causes severe damage, with a higher risk during earthquakes.

Dams are huge barriers built across rivers and streams to restrict the flow of water for purposes such as irrigation and the production of hydroelectricity. Because of the unique interactions with both soil and water, modeling techniques used for conventional buildings are not directly applicable to dams. Assessing the behavior of these dam-reservoir-soil systems is complex and has been approximated and simplified for years. But through new efforts led by a team of researchers at Pisa University in Italy, a renewed accuracy and soundness of dam simulations has been developed and looks to make the future of these gargantuan structures much safer.

Under the influence of earthquake excitation, the concrete gravity dam, water reservoir, and soil foundation behave as a coupled system.

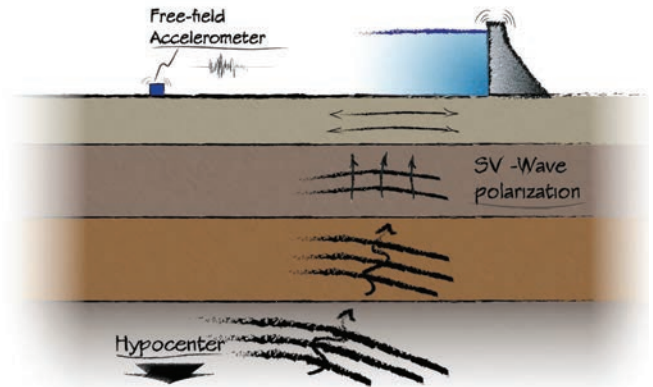

FIGURE 1. Schematic of the waves generated in the terrain by an earthquake.

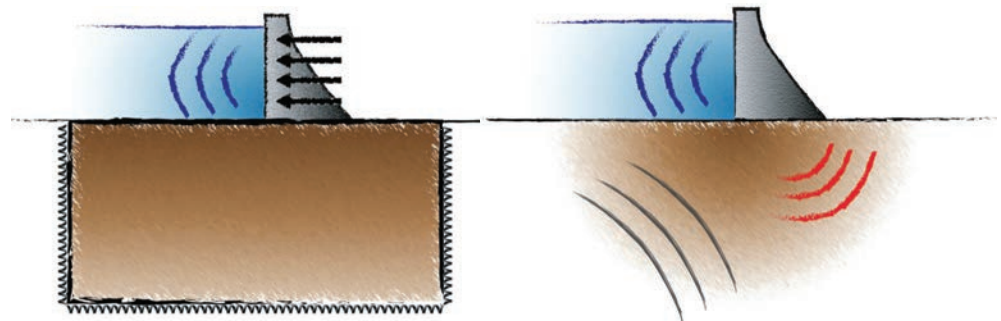

FIGURE 2. Comparisons of the direction of energy transfer between the massless foundation (left) and the infinite terrain model (right).

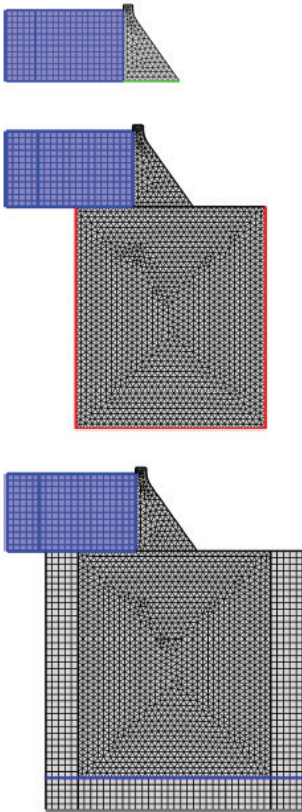

FIGURE 3. Geometry adopted for the three modeling techniques: rigid base (top), massless foundation (middle), and infinite terrain (bottom).

Due to the high complexity involved, the computational sophistication required has not been readily available; thus, the soil-structure interaction is frequently neglected or roughly estimated via simplified assumptions. The risk in not considering these interactions is the possibility of unexpected stress amplifications within the dam body.

⇒ SOIL-STRUCTURE INTERACTION

Both kinematic and inertial effects are part of the soil-structure interaction, but the inertial effects are rarely accounted for. While the kinematics are governed by soil flexibility and are

influenced by the structure's stiffness, the inertial effects are influenced by the structure's and the soil's density properties. Under excitation, the concrete wedge making up a dam moves back and forth in the soil, but the soil is not massless and does not simply move along with the slab. The soil and structure both directly influence each other, and this interaction generates elastic waves that travel through the soil, carrying energy away from the system (Figure 1). This is known as "radiation damping."

Currently, simulating soil effects on seismic behavior consists of a couple of methods, but they all leave something to be desired. Soil effects are considered in conventional building models by using code-provided response spectra based on the type of soil. However, structural differences between conventional buildings and dams render these methods inappropriate. Furthermore, for dams specifically, a technique called the "massless foundation" model (Figure 2) has been extensively implemented in dam-foundation analysis, modeling the soil solely in terms of flexibility and displacement at its boundaries. By disregarding the inertial effects and assuming the soil is "massless", all of the kinetic energy in the system is transferred to the base of the dam, which is unrealistic and results in substantial overestimates of the seismic response.

⇒ UPPING THE COMPLEXITY WITH NUMERICAL SIMULATION

Numerical simulation allowed Matteo Mori of the Department of Energy Engineering of Systems of Land and Construction at Pisa University to explore the full soil-structure interactions in his simulations. "The flexible nature of COMSOL® makes it the most straightforward software to work with, and in our case, we appreciate the breadth of features available for the study of elastic, or acoustics, waves," Mori says. "It is comprehensive in nature and a powerful tool for our research."

The viability of any new technique to model concrete gravity dams needs to be considered in context, so Mori decided to run three different models under multiple scenarios. He investigated the dynamic response of each system under earthquake excitation and compared the findings. The three models, rigid base, massless foundation, and (full) infinite terrain analysis, are shown in Figure 3; each has an additional degree of sophistication beyond the former.

The blue rectangular area represents the water reservoir, the triangular region represents the dam, and the large rectangular region represents the soil. The soil domain in the massless model is simply that, massless soil with only flexibility and displacement.

To ensure consistency across the model types, the horizontal harmonic acceleration boundary condition at the base of the dam (green, red, and blue lines), which simulates the earthquake excitation, is set up such that the base acceleration at the dam is the same for all three models. A global equation feature, available in COMSOL, is used in the third model to ensure that the boundaries allow for waves to pass through.

A key aspect of the infinite terrain model is the perfectly matched layer (PML) surrounding the soil. A powerful feature in the COMSOL Multiphysics® software, PMLs absorb all incident waves, regardless of angle and frequency, preventing them from returning back into the medium after incidence at the boundaries. This feature helps incorporate radiation damping and energy dissipation, treating the unboundedness of the soil domain as a perfectly absorbing material and creating a decaying oscillation of the concrete slab without any reflection of the energy waves.

"COMSOL offers the suitable tools to perform accurate multiphysics simulations, including fully coupled fluid-structure interaction (FSI) analysis and infinite domains," Mori

"The flexible nature of COMSOL® makes it the most straightforward software to work with, and in our case, we appreciate the breadth of features available for the study of elastic, or acoustics, waves. It is comprehensive in nature and a powerful tool for our research."

— MATTEO MORI, DEPARTMENT OF ENERGY ENGINEERING OF SYSTEMS OF LAND AND CONSTRUCTION, PISA UNIVERSITY

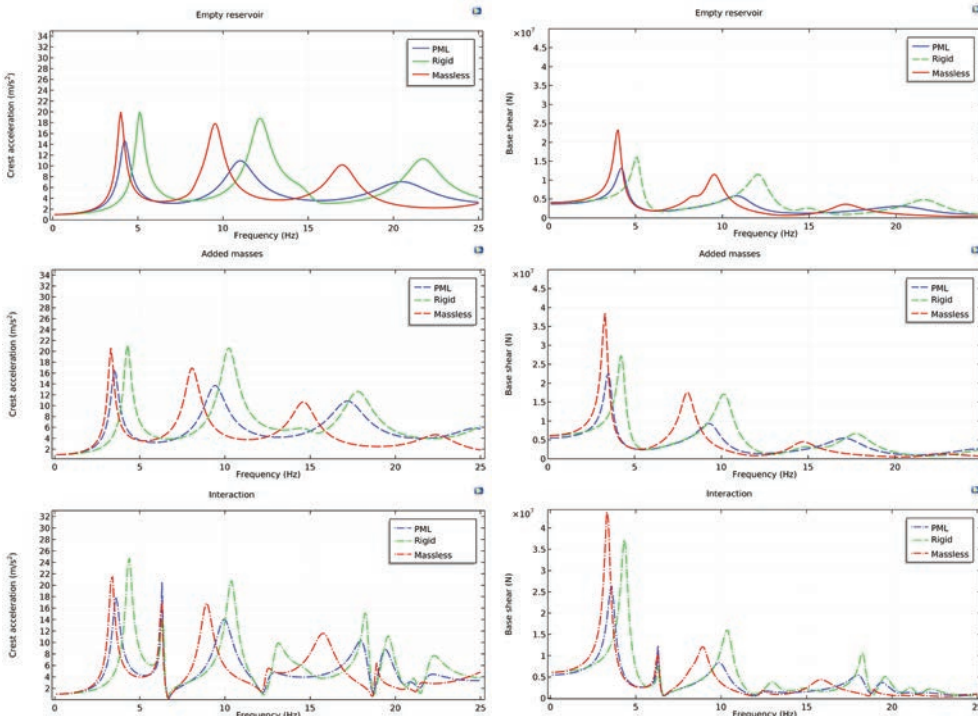

FIGURE 4. Base shear and crest acceleration for an empty reservoir (top), an added mass approach (middle), and a full elastic wave coupling approach (bottom).

says. The fluid subsystem is solved using the Helmholtz equation in the hypothesis of small vibrations and neglected viscosity, the soil and dam subsystem is solved with solid mechanics, and the unbounded terrain is modeled with the PML functionality.

⇒ OBTAINING RESULTS IN CONTEXT

The soundness of the infinite terrain model is assessed by applying multiple scenarios to a 65-meter-tall concrete monolith, namely both empty and filled reservoirs. Furthermore, the filled basin is simulated in two ways: with a full elastic wave coupling and a simplified “added mass” model. Added mass is a way to simulate the hydrodynamic effect of the basin, also known as “virtual mass.” As the slab accelerates, it must also move the neighboring water, as the

two cannot occupy the same physical space simultaneously. This adds inertia and essentially increases the effective mass of the slab.

The results obtained from these simulations are calculated with each technique (rigid base, massless foundation, and infinite terrain) for each basin scenario (empty reservoir, added mass, and full interaction). Compared to the rigid base and massless foundation models, the infinite terrain technique (blue curves, Figure 4) noticeably reduces and smooths the peak responses in all three cases. This smoothing is, as expected, due to the newly implemented considerations of radiation damping. As this phenomenon dissipates energy from the system into the unbounded earth terrain (simulated with the PMLs),

a smaller and more realistic amount of kinetic energy is thus transferred to the slab. The other two modeling techniques fail to account for this.

There are also noticeable differences in the mechanical displacement, fluid pressure, and mechanical energy flux, as shown above in Figure 5. Whereas the massless model displays circulatory streamlines (which represent the acoustic energy flux) without a defined incoming wave front, the infinite terrain model’s energy flux is clearly directionally defined. This is both visually and qualitatively indicative of the radiation damping that transmits energy away from the system, and it confirms that lower amounts of energy are transferred to the dam.

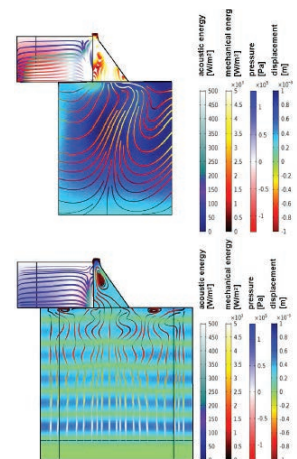

FIGURE 5. Plot of the mechanical displacement, fluid pressure, and mechanical energy flux streamlines for the massless foundation (top) and infinite terrain (bottom).

⇒ FINAL STEPS AND FUTURE WORK

“The fidelity of the model is the biggest challenge in our work because this is not a mathematically perfect problem and accurate predictions are difficult. The infinite terrain model is one method that can be considered a good solution, but there are still some developments required, which we are working on right now,” Mori says. “Concrete is a brittle material,” Mori explains. “We would like to be able to identify cracks in the dam structure.”

They plan on implementing deconvoluted experimental data from accelerograms that monitor seismic activity to set more accurate boundary conditions in their models. This would yield tremendous power and accuracy for dam modeling in Italy as well as all over the world. ❖

Multiphysics Simulation Drives Smart City Technology

Reimagining the utilitarian power box into a modular, modern installment requires a complete design reinvention to balance the physical phenomena at play.

by SARAH FIELDS

Contemporary power boxes (or feeder pillars, as they are known outside of the United States), are mounted in the street and control the electrical supply to dwellings within a neighborhood. As residents increasingly prioritize the aesthetic and continue to place a high value on urban living, there is a need for less conspicuous power boxes.

But as it turns out, there is a valid reason behind the bulky size of the power boxes. The size of the traditional design holds the hardware necessary to reduce the high power of the long-distance power line to a power suitable for distribution to homes and businesses. The worthy goal of reducing the size of the power boxes comes with the additional challenge of routing power with considerably less area while considering resistance and Lorentz forces, a not insignificant undertaking.

Ishant Jain, principal researcher in R&D at Raychem RPG, applied his years of simulation experience to the challenge of creating a smart city-ready and space-conscious power box. He along with his team at Raychem enlisted multiphysics simulation to tackle the engineering challenges that accompanied the creation of this radical new design.

⇒ HOW POWER BOXES WORK

Thanks to this article, you are reminded of that obtrusive metal box near your sidewalk. But how exactly does a power box work?

The enclosure of a power box provides protection to an

electrical distribution system. Its purpose is to distribute the current of a low-voltage supply line, suitable for electrical transport across short distances, into homes and businesses. Power boxes are used to both reduce physical losses of electricity as well as to more precisely distribute and account for the usage of that electricity.

“It is highly beneficial for power boxes to occupy less space,” Jain says, “We could create a modular unit with all of the capabilities of the original model adapted for the needs of cities in the 21st century.”

Jain and his team swiftly noted many aspects of the design of a classical power box to be improved. These upgrades included a reduction of the cost and of the electrical losses due to substandard connections as well as improvements in safety, size, installation ease, serviceability, and aesthetic.

Jain and his team were also motivated to create a futuristic power box that would be readily adopted by smart cities. This new power box would include

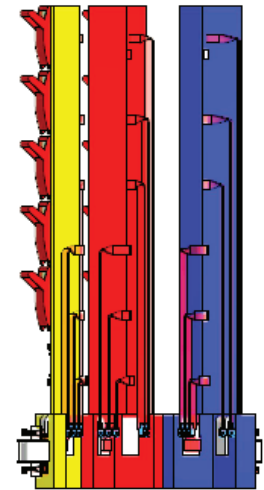

FIGURE 1. The innovative busbar system serves to distribute the same amount of power yet is contained within a smaller space than a conventional power box.

smart features to allow for online monitoring of energy usage, as well as to monitor the health of the system and individual fuses.

⇒ MINIMIZING ELECTROMOTIVE FORCES

The immediate challenge in adapting the geometry of an

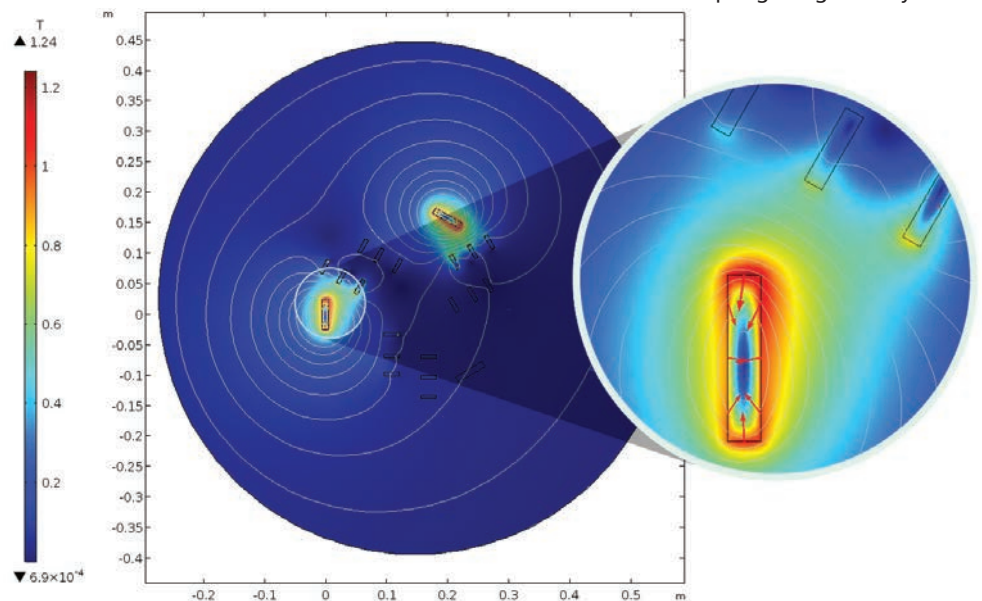

FIGURE 2. Three-phase power box, showing the magnetic flux density norm, surface plot, and the Maxwell surface stress tensor (N/m^2), arrow plot.

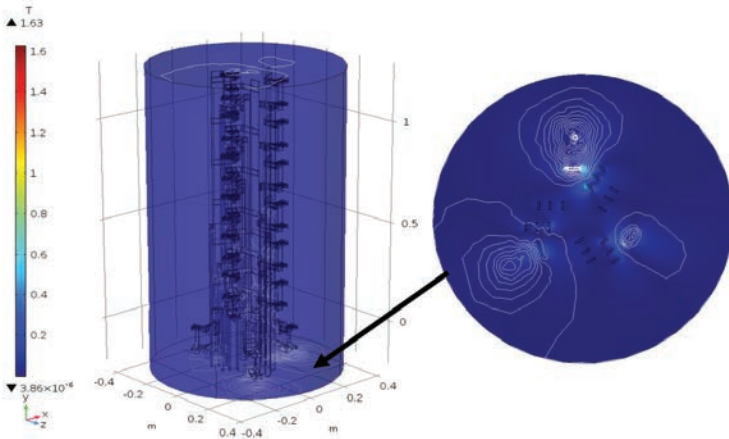

FIGURE 3. Magnetic flux density throughout the power box.

electrical distribution system to a radically small enclosure is the need to mitigate competing electromagnetic forces arising from the change in the design.

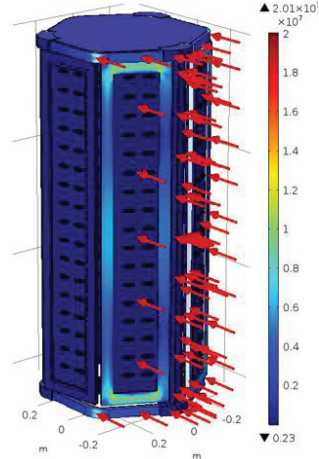

FIGURE 4. Induced von Mises stress at a wind flow velocity of 103 m/s.

Due to the dynamic nature of the physics and the complexity of the geometry, the need for multiphysics simulation in ensuring the stability of the design was immediately evident to the engineers.

To realize such a steep decrease in the size of the power box, the engineers needed to create a busbar system that would distribute the same amount of power yet fit within a smaller geometry (Figure 1).

Jain and his team created a 2D simulation to ensure that their design was suitable to

reduce the cumulative impact of the electromagnetic forces (Figures 2 and 3). The 120° alignment of the panels serves to balance the forces acting on the busbars.

“The simulation gave us confidence that the design would work,” Jain explains, “We could tell that the electromotive forces would be balanced by the 120° alignment.”

⇒ ENSURING THERMAL AND STRUCTURAL INTEGRITY THROUGH SIMULATION

Another important consideration is the overall structural soundness of the power box. For this, Jain and team developed a structural simulation of the power box that would allow them to evaluate its durability. From a time-dependent study of winds of up to 103 m/s blowing against the structure, it was determined that the power box was structurally sound (Figure 4). The engineers also slowly increased the boundary load until the induced stress reached a critical value and determined that the design is safe up to a wind velocity of 570 m/s.

A transient heat transfer analysis of the complete panel assembly was done to ensure the thermal integrity of the system in operation. The validated simulation allowed the team to calculate the temperature rise for conditions that could not be evaluated experimentally. The thermally optimized connectors make the final design safer and more efficient than its predecessors (Figure 5). The resulting design is also modular and scalable (Figure 6).

⇒ VERSATILE MODELING FOR BETTER DESIGN

Jain and his team were able to create a design (Figure 6) that is much smaller but can still dissipate the same level of power and current as traditional power boxes. The final power box design takes up the least amount of space of all power boxes on the market and is thermally sound and efficient.

“Using multiphysics simulation, we were able to ensure the integrity of the final contemporary design,” Jain concludes,

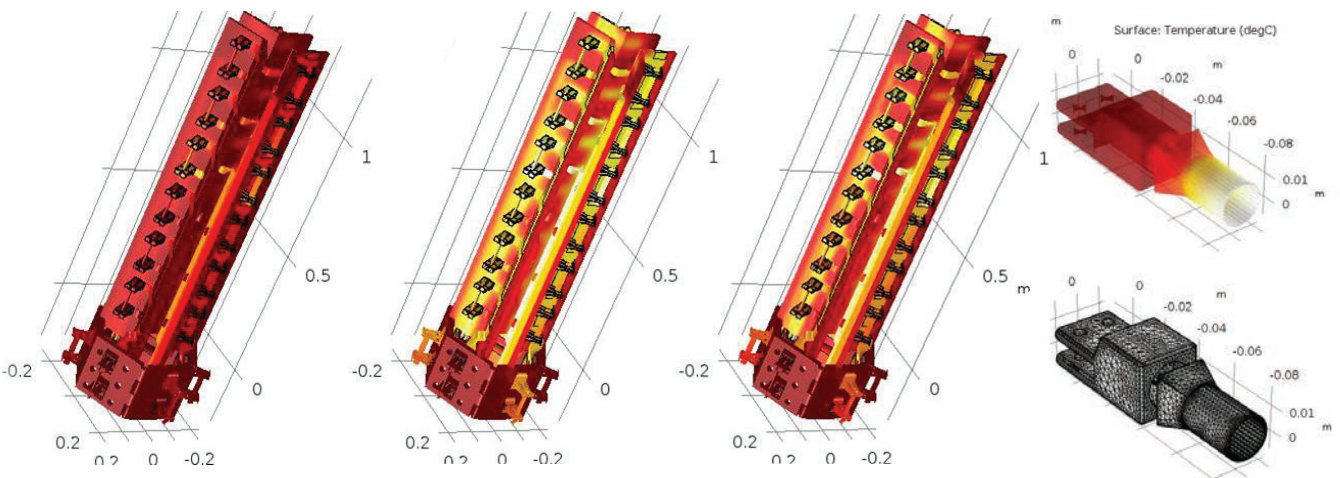

FIGURE 5. Simulation results from a transient analysis of the power box’s thermal profile (left) the power box and connectors (right).

“We think that the benefit and impact will be far-reaching as it is adopted across the world.”

The final design includes smart features such as a safety and theftproof system as well as the capability for remote monitoring of energy, fuse health, and the thermal profile. It includes fuse housings that are insulated and safe to work with while the system is operating as well as connectors with lower resistive losses.

Suffice to say, in developing a power box that is a fraction of the size of the industry standard, with its reimaged and efficient busbar system, Jain and his team succeeded in reinventing the power box, using multiphysics simulation at every step. ❖

This work was supported by Raychem RPG Ltd. We would like to express our gratitude to D Sudhakar Reddy at Raychem Innovation Centre for

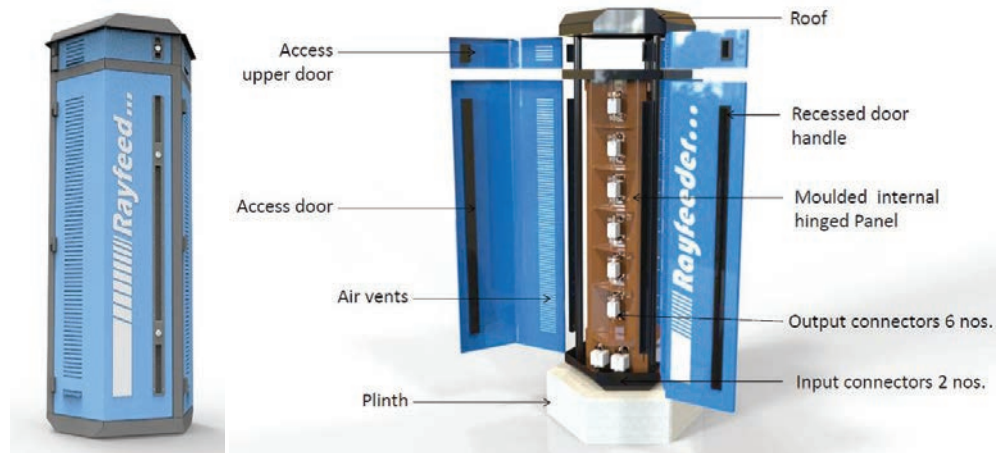

FIGURE 6. Engineers at Raychem developed an innovative, smart city-ready power box design.

his guidance during the project. We thank Sumit Zanje, Nitin Pandey, Sanjay Mhapalkar, and Jayesh Tandlekar for their unrelenting spirit and commitment during the course of completion of the work. We would like to thank the COMSOL team (Bangalore and Pune) that provided insight and expertise that greatly assisted the research.

“Using multiphysics simulation, we were able to ensure the integrity of the final contemporary design. We think that the benefit and impact will be far-reaching as it is adopted across the world.”

— ISHANT JAIN, PRINCIPAL RESEARCHER IN R&D AT RAYCHEM RPG

LORENTZ FORCE CALCULATIONS IN COMSOL by Durk de Vries

The electromagnetic forces that the busbars in the power box are subjected to are known as Lorentz forces. Lorentz forces arise when a current is passing through a magnetic field (as opposed to electrostatic forces or forces between magnets). Just how powerful a Lorentz force can be is illustrated by some railgun designs: With a high-enough current, busbar systems can be ripped apart. Another issue occurs with constantly varying loads (fatigue problems).

In the COMSOL® software, Lorentz forces can be evaluated in various ways. One way is by using the Maxwell surface stress tensor. The projection of this tensor is available on the exterior boundaries of the busbar as an electromagnetic pressure. In the *Magnetic Fields* physics interface in the AC/DC Module, the *Force Calculation* domain feature integrates this pressure and derives lumped quantities, such as the total force and torque on the busbar. Alternatively, the pressure can be used locally, like in a structural mechanics model.

Another way to determine the Lorentz forces is to evaluate the cross product between the current density, J , and the magnetic flux density, B . The vector field resulting from this computation has been predefined as the Lorentz force contribution. Integrating it over the volume will give the total force on the busbar. Generally speaking, the volume integral results in a much more accurate figure than the surface stress tensor boundary integral, but the boundary integral approach is more versatile. Both methods are demonstrated in the *Electromagnetic Forces on Parallel Current-Carrying Wires*, tutorial model available online in the COMSOL Application Gallery.

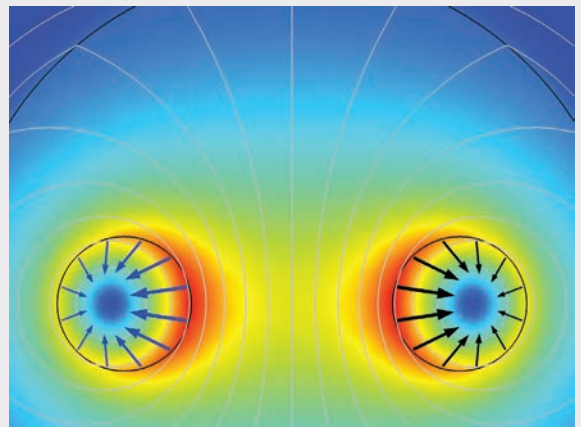

Electromagnetic forces on parallel current-carrying wires.



KEEPING DENDRITES AT BAY WITH NUMERICAL SIMULATION

Numerical simulation drives the development of new approaches in lithium-ion battery research.

by **SARAH FIELDS**

Lithium-ion batteries can come in the form of laminated lithium-ion batteries for mobile electronic devices, cylindrical batteries for industrial power tools, and other cylindrical batteries for energy storage systems. The R&D division of Murata Manufacturing Co., Ltd., is using multiphysics simulation to examine batteries using lithium metal as a negative electrode material.

Dendrites, needle-like growths, are a fierce antagonist to efficient lithium-ion battery functioning. Dendrites form when a current is applied to a lithium metal electrode and can cause unwanted side reactions that result in short-circuiting, drastically limiting the life of the battery.

Mitigating dendrite formation is an active area of research for the entire battery industry. Most researchers approach the problem of safety hazards and life span due to dendrite formation by changing the chemistry in some way. However, gains in this area have been painstakingly slow, prompting some researchers to take an alternative path.

When examining batteries that use lithium metal as a negative electrode material, Jusuke Shimura a R&D

engineer at Murata looked to investigate the effect of changing the charging current pattern on dendrite formation.

This approach is gaining traction in the battery and energy storage world as the industry ramps up to meet the needs of an era of electrification and renewable energy.

⇒ USING MULTIPHYSICS TO MINIMIZE DENDRITES

Lithium dendrite occurs when current is applied to the lithium metal electrode, resulting in a short circuit. "In order to commercialize lithium-ion batteries with lithium metal electrodes, this problem must be solved," says Shimura.

The key to his approach was identifying a current pattern for charging that would minimize the growth of lithium dendrites. This approach works because at the off-time between pulses, the concentration gradient at the electrode interface decreases, minimizing dendrite buildup. Also, introducing reverse pulses in the current pattern plays an important role by repeatedly dissolving formed dendrites.

To capture the electrochemical effects over his geometry, Shimura enlisted the

battery modeling capabilities of COMSOL Multiphysics®. He used a combination of experimental evidence and simulation to determine the best charging pattern.

Many researchers have been exploring this challenge from a chemical and material perspective. To make strides in this area, Shimura wanted to establish a baseline understanding of his physical system experimentally. It was important

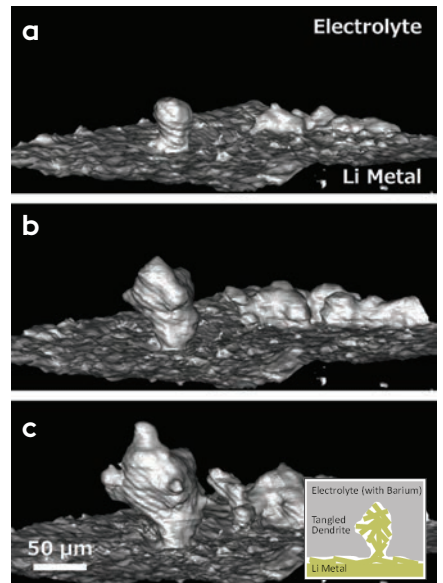

FIGURE 1. X-ray computed tomography (CT) results showing that the surface of electrolyte membrane is pushed up by lithium dendrites due to flowing current of $50 \mu\text{A}/\text{cm}^2$ for 6 h (a), 13 h (b), and 20 h (c).

“Thanks to COMSOL, we were able to show with a first-principles-based simulation that the optimized charging pattern improved the lifetime of the battery.”

— JUSUKE SHIMURA, RESEARCH ENGINEER AT MURATA MANUFACTURING CO. LTD.

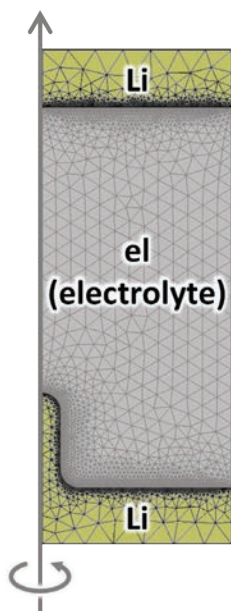

FIGURE 2. Mesh of the lithium-ion battery geometry.

for him to understand the shape of dendrite formation over time. To accomplish this, he created an X-ray CT-compatible laminated cell that contains a contrast agent in its

electrolyte membrane, and visually measured the formation of dendrites over time (Figure 1).

“I created a laminated cell that could be imaged with X-ray computed tomography, so that I would know where the dendrites are forming. Then, I used COMSOL® to find the best pulse pattern of charging to limit dendrite growth based on the shape and the size of the formed dendrites,” explains Shimura.

With the data from the X-ray computed tomography Shimura created a model of a lithium metal cell and analyzed the effect of changing the current pattern. The results showed how much lithium metal precipitated onto the dendrite (Figure 2).

Using multiphysics modeling, Shimura evaluated various current patterns to determine the current pattern with the slowest rate of dendrite formation (Figure 3). This method allowed him to examine which has more lithium deposition — the electrode surface with planar diffusion (bottom part of Figure 3) or the dendrite with spherical-like diffusion (left part of Figure 3) through one cycle of the pulse pattern.

He ultimately found that a repetition of reverse pulse for 20 seconds, off-time for 10 seconds, forward pulse for 20 seconds, and off-time for 10 seconds resulted in the least dendrite growth (Figure 4).

“With this pattern, we saw the growth rate of dendrites becomes less than

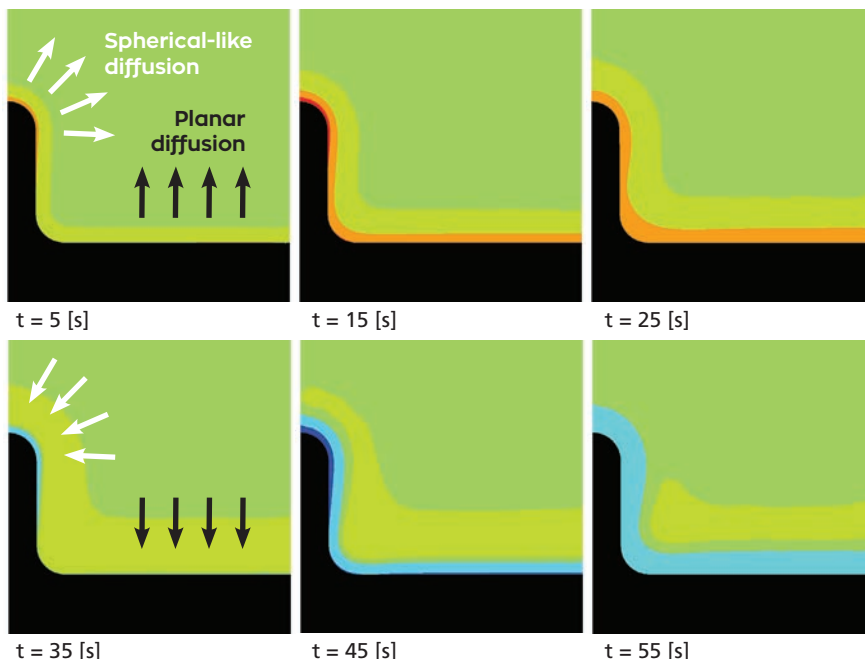

FIGURE 3. Simulation results of the dendrite growth with different pulse charging patterns.

one-third. As we expected, this was accomplished solely by changing the charging pattern — the chemistry stayed the same,” Shimura explains.

Shimura’s simulation was based on the experimentally determined size of the dendrite. It made use of the battery modeling capabilities of COMSOL Multiphysics that enlist the concentration-dependent Butler-Volmer equation to model the reactions of the electrodes and coupled diffusion-migration equations to model the lithium-ion transport.

⇒ DEVELOPING THE BATTERIES OF THE FUTURE

Using simulation, Shimura found the best pulse pattern to charge a lithium-ion battery with a lithium metal electrode. Compared to applying direct current, this approach improved the lifetime of the battery more than three times. “Thanks to COMSOL, we were able to show with a first-principles-based simulation that the optimized charging pattern improved the lifetime of the battery,” Shimura says.

In the future, Shimura sees multiphysics simulation playing a continuing role in maintaining the fast pace of their research and concludes: “We look forward to continuing to use COMSOL to bring the advantages of

optimized charging patterns to batteries on the market.” ❖

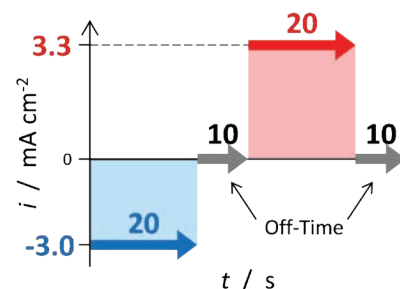

FIGURE 4. This pulse pattern was determined to be the best by finite element method simulation for the laminated cell. With the optimized current pattern, it is easier to dissolve lithium from the dendrite and more difficult to deposit lithium on the dendrite.



Dr. Jusuke Shimura is a research engineer at Murata.

Collaboration Is Key for Individualized Medicine

by **DAVID ENFRUN, CEO & COFOUNDER OF KEJAKO**

In the field of medical technology, we strive to transform lives through innovative solutions that improve the daily lives of our patients. From product development, to the customization of a patient's actual needs, to the postmarket survey, simulation has a role to play. Sooner or later, the use of simulation will be a standard in the medical technology industry.

In the R&D department, our job always starts with the physics to build a model, whether we are using simulation to reverse engineer an existing solution or to test new products and scenarios. The goal of simulation is to retrieve all necessary insights for product development in order to reach in silico proof of concept before prototyping and in vivo trials. Simulation is our guarantee toward the path of performance and safety. Our experience has proven that the hours spent in numerical simulation are worth years spent in development.

“It is clear that COMSOL envisioned the power of multiphysics simulation when they introduced the Application Builder. Simulation applications allow other departments to test different configurations for their particular requirements and pick the best design.”

When a model is accurate enough, the prototyping phase is significantly reduced.

Beyond the R&D department, numerical simulation has the capability to serve as the path toward individualized medicine. Imaging and diagnosis techniques have reached a high level of standards. The next step that we envision for the future is to upload the biometry into a parametric model where calculation tools finalize the diagnosis and allow a physician to preplan a customized solution before any procedure is conducted. The possibilities of personalized healthcare have the ability to transform lives through meaningful innovation.

It is clear that COMSOL envisioned the power of multiphysics simulation when they introduced the Application Builder. Simulation applications allow other departments to test different configurations for their particular requirements and pick the best design.

Internally, simulation applications have enabled us to foster a culture of collaboration. From an R&D perspective, it's

very useful to be able to share a specific interface with just the parameters relevant to a particular group, knowing the model and physics are protected. This allows all departments to benefit from multiphysics simulation. With this level of collaboration, the model expands to serve as a physical benchmark, with more or fewer features depending on the end user.

Additionally, simulation applications have the potential to embed a multiphysics model within the workflow of a healthcare professional. This technology will provide them with the full picture of the diagnosis, empowering them to execute a new level of custom treatment planning.

As the CEO of Kejako, I am excited about the future of medicine and the revolution where simulation expertise and medical technologies will join forces!

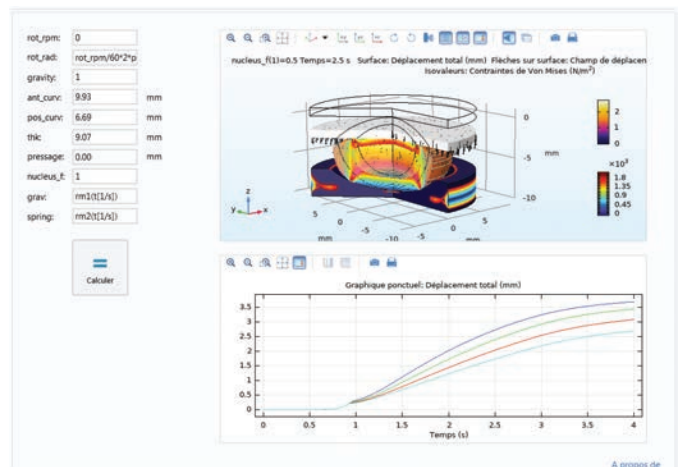

Simulation application of a parametric 3D eye simulation for physical benchmarking to be used in a clinical setting.



ABOUT THE AUTHOR

David Enfrun, MSc from Arts et Métiers Paris (France), CEO & cofounder of Kejako, has 20 years of experience in the medical devices industry on its technology side for ophthalmology, aesthetics, and cardiology. David strives to position Kejako with the appropriate partners and in the right direction, including the use of simulation in the field of individualized ophthalmology.